



Full Touch

XR30T - XR60T - XR70T



(V.1.2)

INDEX

1.	IMPORTANT USER INFORMATION.....	4
2.	PRODUCT DISPOSAL (WEEE).....	5
3.	GENERALITIES.....	6
3.1	USEFUL INFORMATION.....	6
4.	USER INTERFACE.....	6
4.1	SCREENS.....	6
4.2	ICONS.....	7
4.3	GESTURES.....	9
4.4	HOME BROWSING.....	9
4.5	STAND-BY MODE.....	9
4.6	PROGRAMMING MENU.....	9
4.7	SETPOINT MENU.....	10
4.8	HOTKEY – UPLOAD.....	10
4.9	HOTKEY – DOWNLOAD.....	10
4.10	X9.....	10
4.11	PARAMETER MENU.....	11
4.12	PASSWORD MENU.....	12
5.	PARAMETER TABLE.....	12
5.1	PARAMETER DESCRIPTION.....	12
5.1.1	Main regulation parameters - rEG.....	12
5.1.2	Probe configuration parameters – Prb.....	13
5.1.3	Visualization parameters - diS.....	13
5.1.4	Defrost configuration parameters - dEF.....	13
5.1.5	Evaporator and condenser fan configuration parameters - FAn.....	14
5.1.6	Auxiliary regulator parameters - AUS.....	15
5.1.7	Alarm configuration parameters.....	15
5.1.8	Digital and analogue output configuration parameters - out.....	16
5.1.9	Digital input configuration parameters - inP.....	16
5.1.10	Energy saving configuration parameters - ES.....	17
5.1.11	Counters, read only values - Cnt.....	17
5.1.12	Real Time Clock configuration parameters - rtC.....	17
5.1.13	Memory storage management – E2.....	18
5.1.14	Serial Communication port configuration parameters - CoM.....	18
5.1.15	User Interface configuration parameters - Ui.....	18
5.1.16	Information, read only parameters - inF.....	18
5.2	PARAMETER CONFIGURATION 1.....	18
5.3	PARAMETER CONFIGURATION 2.....	24
6.	REGULATION.....	29
7.	ENERGY SAVING.....	29
7.1	BASIC ENERGY SAVING ALGORITHM.....	29
7.1.1	PARAMETERS INVOLVED.....	29
8.	PULL DOWN FUNCTION.....	29
9.	DEFROST OPERATIONS.....	30
9.1	TIMED OR TEMPERATURE CONTROLLED MODE.....	30
10.	EVAPORATOR FAN.....	30
10.1	EVAPORATOR FAN AND DIGITAL INPUT.....	30
11.	CONDENSER FAN.....	30
12.	DIGITAL OUTPUTS.....	31
12.1	COMPRESSOR OUTPUT (oAx = CP1).....	31
12.2	DEFROST OUTPUT (oAx = DEF).....	31
12.3	EVAPORATOR FAN OUTPUT (oAx = FAn).....	31
12.4	ALARM OUTPUT (oAx = ALR).....	31
12.5	LIGHT OUTPUT (oAx = LiG).....	31
12.6	AUXILIARY OUTPUT (oAx = AUS).....	31
12.6.1	AUXILIARY REGULATOR.....	31
12.6.2	TIMED ACTIVATION.....	31
12.6.3	GENERAL NOTES.....	31
12.7	DEAD BAND REGULATION (oAx = DB).....	31
12.8	ON/OFF OUTPUT (oAx = ONF).....	31
12.9	ENERGY SAVING OUTPUT (oAx = HES).....	32
12.10	CONDENSER FAN OUTPUT (oAx = Cnd).....	32
12.11	SECOND COMPRESSOR OUTPUT (oAx = CP2).....	32
12.12	SECOND DEFROST OUTPUT (oAx = dF2).....	32
12.13	HEATER OUTPUT (oAx = HET).....	32
12.14	INVERTER OUTPUT (oAx = INV).....	32
13.	DIGITAL INPUTS.....	32
13.1	DOOR SWITCH (ixF=DOR).....	32
13.2	START DEFROST (ixF=dEF).....	32
13.3	AUXILIARY OUTPUT (ixF=AUS).....	32
13.4	ENERGY SAVING (ixF=ES).....	32

13.5	EXTERNAL WARNING ALARM (iXF=EAL)	32
13.6	EXTERNAL LOCK ALARM (iXF=BAL)	32
13.7	EXTERNAL PRESSURE ALARM (iXF=PAL)	33
13.8	EVAPORATOR FAN MODE (iXF=FAN)	33
13.9	REMOTE HOLIDAY MODE (iXF=HdF)	33
13.10	REMOTE ONOFF (iXF=ONF)	33
13.11	LIGHT OUTPUT (iXF=LIG).....	33
13.12	CHANGE CONFIGURATION (iXF=CC).....	33
13.13	MOTION SENSOR DETECTOR (iXF=EMT).....	33
14.	ALARM SIGNALLING.....	33
14.1	ALARM RECOVERY	33
15.	SERIAL COMMUNICATION.....	33
16.	INSTALLATION AND MOUNTING	34
17.	WIRING DIAGRAM	34
17.1	XR70T	34
17.2	XR60T	34
17.3	XR30T	34
18.	TECHNICAL SPECIFICATIONS.....	35
19.	APPENDIX.....	36
19.1	TOOLS	36
19.1.1	<i>XH-REP</i>	36
19.1.2	<i>X-MOD</i>	36
19.1.3	<i>WIZMATE</i>	36
19.1.4	<i>HOTKEY</i>	36
19.1.5	<i>USB TO RS485 CONVERTER</i>	36
19.2	EXAMPLE OF MENU NAVIGATION AND PARAMETER MODIFICATION	37

1. IMPORTANT USER INFORMATION

- The  symbol is intended to alert the user of a non-insulated voltage source within the product area that is sufficiently high to constitute a risk of electric shock to persons.
- The  symbol is intended to alert the user of important operating and maintenance (servicing) instructions.
- Dixell Srl reserves the right to modify this user's manual at any time without prior notice. The documentation can be downloaded from the website **www.fulltouch.info** even prior to purchase.
- This manual is an integral part of the product and must always be kept near the device for easy and quick reference. The product cannot be used as a safety device. Please read this manual very carefully be sure you understand the information provided before using the device.
- Verify that the power supply voltage is correct before connecting the device. Do not expose it to water or humidity: use the controller only within the operating limits, avoiding sudden temperature changes and high atmospheric humidity in order to prevent condensation from forming. Recommendations: disconnect all the electrical connections before performing any maintenance task; insert the probe where it cannot be reached by the End User; the device must not be opened; consider the maximum current that can be applied to each relay; make sure that the wires of the probes, of the loads and the electrical power supply cables are sufficiently separated from each other, without crossing or intertwining. In case of applications in industrial environments, it may be useful to use the main filters as well as the inductive loads.
- The customer shall bear full responsibility and risk for product configuration in order to achieve the the final installation of the equipment/system. Upon the customer's request and following a specific agreement, Dixell Srl may be present during the start-up of the final machine/application, as a consultant, however, under no circumstances can the company be held responsible for the correct operation of the final equipment/system.
- Since Dixell products are part of a high-level technology, a qualification and a configuration/programming/commissioning stage is required to best use them. Otherwise, these products may malfunction and Dixell cannot be held responsible. The product must not be used in any way that differs from that stipulated in the documentation.
- The device must always be installed inside an electrical panel that can only be accessed by authorised personnel. For safety purposes, the keyboard must be the only part that can be reached.
- The electrical wiring connections must never be modify while the device is being used.

- It is good practice to bear in mind the following indications for all Dixell products:
 - Prevent the electronic circuits from getting wet as contact made with water, humidity or any other type of liquid can damage them. Comply with the temperature and humidity limits specified in the manual in order to store the product correctly.
 - The device must not be installed in particularly hot environments as high temperatures can damage the electronic circuits and/or plastic components forming part of the casing. Comply with the temperature and humidity limits specified in the manual in order to store the product correctly.
 - Under no circumstances is the device to be opened - the user does not need any internal component. Please contact qualified service personnel for any assistance.
 - Prevent the device from being dropped, knocked or shaken as either can cause irreparable damage.
 - Do not clean the device with corrosive chemical products, solvents or aggressive detergents.
 - The device must not be used in applications that differ from that specified in the following document.



- ***Separate the power supply of the device from the rest of the electrical devices connected inside the electrical panel. The secondary of the transformer must never be connected to the earth.***
- Dixell Srl reserves the right to change the components of its products, even without notice, ensuring the same and unchanged functionality.

2. PRODUCT DISPOSAL (WEEE)

In compliance with the Directive 2002/96/EC of the European Parliament and of the Council of January 27th 2003 and to the relative national legislation, please note that:

- There lies the obligation not to dispose of electrical and electronic waste as municipal waste but to separate the waste.
- Public or private collection points must be used to dispose of the goods in accordance with local laws. Furthermore, at the end of the product's life, it is also possible to return this to the retailer when a new purchase is made.
- This equipment may contain hazardous substances. Improper use or incorrect disposal can have adverse effects on human health and the environment.
- The symbol shown on the product or the package indicates that the product has been placed on the market after August 13th 2005 and must be disposed of as separated waste.
- Should the product be disposed of incorrectly, sanctions may be applied as stipulated in applicable local regulations regarding waste disposal.



Please consider the environment before printing this manual.

3. GENERALITIES

The XR-T is a microprocessor-based controller suitable for applications on medium or low temperature ventilated refrigeration units. It has 4 relay outputs to control compressor, fans, light and defrost or auxiliary outputs. The device is also provided with up to 4 NTC, PTC or PT1000 probe inputs. There are up to 2 configurable digital inputs. By using the **HOT-KEY** it is possible to program the device quickly and easily. The controller implements Full Touch technology.

3.1 USEFUL INFORMATION



Stay tuned on www.fulltouch.info

CONTACT: dixell.service@emerson.com







4. USER INTERFACE







XR-T has a capacitive user interface with Full Touch technology. The whole display area is used to interact with the device. Specific gestures are used to enable or disable functions, browse through screens and operational modes and modify the configuration of the device.







4.1 SCREENS

SCREEN	DESCRIPTION
	<p>Home: this screen shows temperature value, measurement unit and active alarms only. This is the first screen after power on or after exit from other status</p>
	<p>Virtual Keyboard: this screen shows available functions. Activated function will blink when this screen is visualized.</p>
	<p>Info: This screen shows activated functions and regulation outputs (compressor, ventilators).</p>
	<p>Programming Mode: This screen enables the modification of the Set point or parameters.</p>





	Setpoint Menu: This screen enables the modification of the Set Point value.
	Parameter Menu: These screens enable the modification of all parameter values.
	Stand-By: in this condition all outputs are deactivated.
	HotKey Download: "PRG" blinks during download operations (copy from HotKey to the internal memory)
	HotKey Upload: "PRG" blinks during upload operations (copy from internal memory to the HotKey)
	X9: it is possible to create the label of the parameter to be visualized or modified.

4.2 ICONS

	DESCRIPTION	MODE	FUNCTION
	LIGHT	OFF	Function not available
		FLASH	When in the Virtual Keyboard screen: light output ON
		ON	When in the Virtual Keyboard screen: light output OFF
	COMPRESSOR	OFF	When in the Loads Info screen: compressor output OFF
		FLASH	Anti short cycle delay is running
		ON	When in the Loads Info screen: compressor output ON
	FAN	OFF	When in the Loads Info screen: evaporator fan output OFF
		FLASH	Activation delay is running
		ON	When in the Loads Info screen: evaporator fan output ON
	DEFROST	OFF	Function not available
		FLASH	When in the Virtual Keyboard screen: defrost ON
		ON	When in the Virtual Keyboard screen: defrost OFF
AUX	AUX	OFF	Function not available
		FLASH	When in the Virtual Keyboard screen: AUX output ON
		ON	When in the Virtual Keyboard screen: AUX output OFF

ECO	ENERGY SAVING	OFF	Function not available
		FLASH	When in the Virtual Keyboard screen: energy saving ON
		ON	When in the Virtual Keyboard screen: energy saving OFF
	PULL DOWN	OFF	Function not available
		FLASH	When in the Virtual Keyboard screen: pull down ON
		ON	When in the Virtual Keyboard screen: pull down OFF
	ALARM	OFF	No alarm is active
		FLASH	
		ON	Some alarm is active
°C	Celsius Degree	OFF	Not used
		FLASH	Not used
		ON	Measurement units: Celsius degree
°F	Fahrenheit Degree	OFF	Not used
		FLASH	Not used
		ON	Measurement units: Fahrenheit degree
	ONOFF	OFF	
		FLASH	
		ON	Only and always ON icon when the device is in standby mode
	PROG LEVEL 1	OFF	
		FLASH	PROG LEVEL 1 and PROG LEVEL 2 icons toggle when the visualized value is editable
		ON	First level (parameter groups) of the parameter menu is visualized
	PROG LEVEL 2	OFF	
		FLASH	PROG LEVEL 2 and PROG LEVEL 1 icons toggle when the visualized value is editable
		ON	Second level (parameter labels) of the parameter menu is visualized
	RADIO ON	OFF	Not used
		FLASH	Not used
		ON	Not used
PRG	PROGRAMMING MODE	OFF	Programming mode disabled
		FLASH	
		ON	Programming mode enabled
	BACK	OFF	
		FLASH	
		ON	Used to go back to previous levels on the menu tree
SET	ENTER	OFF	Set point menu disabled
		FLASH	
		ON	Set point menu enabled
...	BROWSING	OFF	No other (lateral) screens available
		FLASH	
		ON	Other (lateral) screens available

4.3 GESTURES

GESTURE	NAME	HOW-TO	DESCRIPTION
	ONE TAP	Press a specific area of the screen with a finger for 1 sec	Switch ON / Switch OFF: when in Virtual Keyboard, use this to turn on/off a specific function. When in Programming mode, use this to select a parameter or a parameter value.
	TAP and HOLD	Press any place of the screen with a finger for 3 sec	Enter / Save: use this to enter Programming mode or Parameter menu and to save modifications. When in Virtual Keyboard, use this on the "ONOFF" to switch OFF and ON the device.
	H-SWIPE	Drag a finger across the screen, from left to right or from right to left	Browse: use horizontal swipe (right to left or left to right) to browse through HOME, Virtual Keyboard and Info View. When in programming mode: use horizontal swipe to browse through parameter menu.
	V-SWIPE	Drag a finger across the screen, from top to bottom or from bottom to top (overlapping only one of the digits)	Modify: use vertical swipe (from top to bottom or bottom to top) to change a parameter value.

4.4 HOME BROWSING



Use H-SWIPE to move through the screens. The logic implements a circular browsing: H-SWIPE to left or right is possible. A programmable timeout is implemented to return **HOME** from any lateral screen.

4.5 STAND-BY MODE

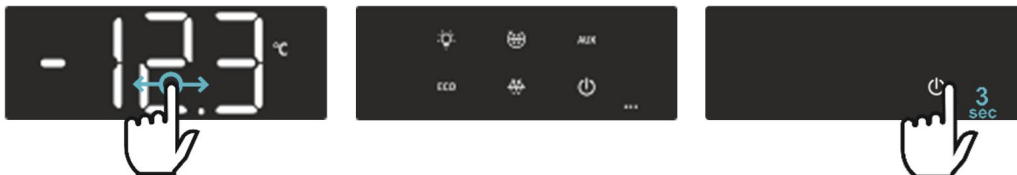

When in **HOME** screen, H-swipe to go to the Virtual Keyboard screen and then touch the **OFF** icon for 3 sec. All outputs and alarms are deactivated in Stand-by mode.

4.6 PROGRAMMING MENU

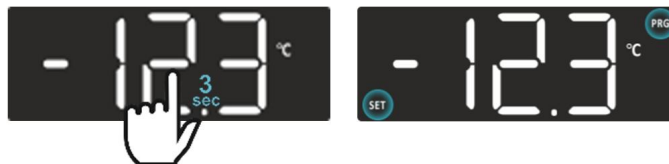

It is possible to unlock the programming menu by touching any area of the display for 3 sec. Both **SET** and **PRG** icons will blink until the programming menu is unlocked.

4.7 SETPOINT MENU

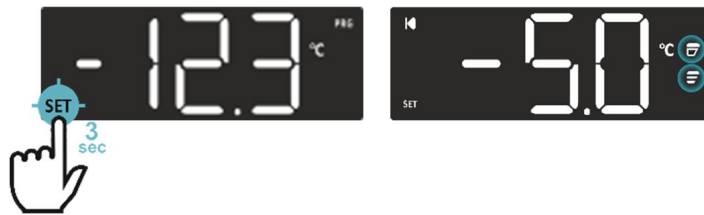

When in **Programming Menu**, it is possible to enter the **Setpoint Menu** by touching the **SET** icon for 3 sec. Both **SET** and **PRG** icons will blink until the **Setpoint Menu** is unlocked. Both **PROG LEVEL** icons start toggling to indicate that the visualized value is editable. Press the **BACK** icon to exit (come back to the **Programming Menu**) without saving.

4.8 HOTKEY – UPLOAD



When in **Programming Menu**, it is possible to activate the **HotKey Upload Menu** function to save the current device configuration (parameter values) into the external memory. To do this, follow these instructions:

1. H-swipe to go on the **UPL** screen
2. Insert the HotKey (on the 5-pin ports on the back of the device)
3. Touch the **PRG** icon for 3 sec
4. The copying procedure will start and the **PRG** icon will blink during the copy operations
5. At the end of the copying procedure, a message will notify the user that the operation has been completed successfully:
 - a. **End**: all parameters have been copied
 - b. **Err**: some error occurs during copying operations

4.9 HOTKEY – DOWNLOAD

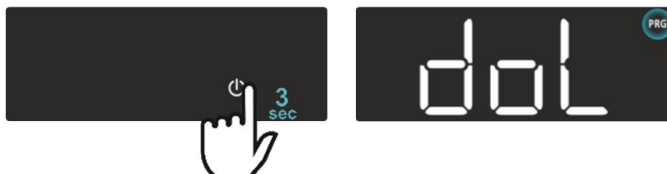

When in **Power-off** or in **Stand-by** mode, it is possible to activate the **HotKey Download Menu** function to copy a new configuration (parameter values) into the current device memory. To do this, follow these instructions:

1. Insert the HotKey (on the 5-pin ports on the back of the device)
2. Touch the **OFF** icon for 3 sec
3. After power-on, the copying procedure will start automatically and the **PRG** icon will blink during the copy operations
4. At the end of the copying procedure, a message will notify the user that the operation has been completed successfully:
 - a. **End**: all parameters have been copied
 - b. **Err**: some error occurs during copying operations

4.10 X9

Every parameter is normally identified by a unique label that can have two or three alphanumeric characters. When in the “**X9**” Screen, it is possible to create the parameter label by swiping-up every single part of the label itself (first, second and third char). The system is able to drive the user through the available symbols, showing only the available ones to speed up the creation of the label.

For example, if a modification of the “interval between defrosts” parameters is required (label “idF”), these are the steps to follow:

- Enter the **X9** screen
- Swipe-up or down the first char position (lower segment on the left) until char “i” (lowercase) appears

- Move to the second char position (segment in the middle) and swipe-up or down until char “d” appears
- Move on the third char position (segment on the right) and swipe-up or down until char “F” appears
- Enter the par. value by touching the **PRG** icon for 3 sec.

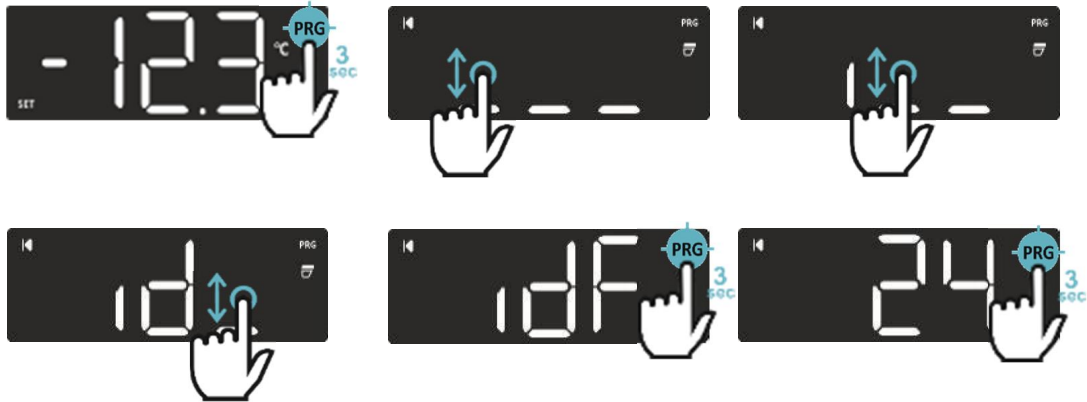

NOTE: pay attention to the upper or lower case when browsing through the available characters. For simplicity, here is the complete list of available characters: A, b, C, d, E, F, G, H, i, L, M, n, o, P, q, r, S, t, u, V, Y, 0, 1, 2, 3, 4, 5, 6, 7, 8 and 9.

4.11 PARAMETER MENU



When in **Programin Menu**, it is possible to enter the **Parameter Menu** touching the **PRG** icon for 3 sec. The **Prog Level 1** icon will indicate the first level of the programming menu (group labels). The **Browsing** icon will indicate that there are other groups of parameters.



When in **PROG LEVEL 1**, it is possible to browse through the available groups of parameters by using the H-swipe gesture. The circular construction of this menu permits to move left or right through the groups. Here are the available groups:

Group Label	Description
rEG	Main regulation parameters
Prb	Probe configuration parameters
diS	Visualization parameters
dEF	Defrost configuration parameters
FAn	Evaporator and condenser fan configuration parameters
AUS	Auxiliary regulator parameters
ALr	Alarm configuration parameters
oUt	Digital and analogue output configuration parameters
inP	Digital input configuration parameters
ES	Energy saving configuration parameters
Cnt	Counters, read only values
rtC	Real Time Clock configuration parameters
E2	Memory storage management

CoM	Serial Communication port configuration parameters
Ui	User Interface configuration parameters
inF	Information, read only parameters
PAS	Password for entering protected menu parameters

4.12 PASSWORD MENU

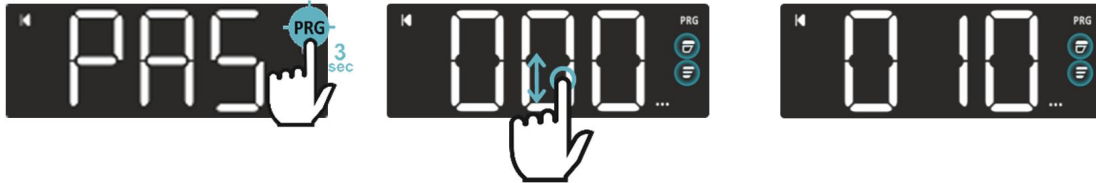

When in the **PAS** group, it is possible to set the password value by touching the **PRG** icon for 3 sec. V-swipe on a single digit to modify the value, then confirm the password value by touching the **PRG** icon for 3 sec.



The new value will blink and after 2 sec the display will show:

- **Pr2** if the password is correct
- **Err** if the password value is wrong

After 2 sec the display will show the first group label (**rEG**) with a blinking **PRG** icon to indicate that protected parameters now are editable.

5. PARAMETER TABLE

Here are the descriptions of the device parameters.

5.1 PARAMETER DESCRIPTION

5.1.1 Main regulation parameters - rEG

SEt	Set Point: range from LS to US
LS	Minimum Set Point: (-100.0°C to SET; -148°F to SET) fix the minimum value for the set point.
US	Maximum Set Point: (SET to 200.0°C; SET to 392°F) fix the maximum value for the set point.
HY	Compressor regulation differential in normal mode: (0.1 to 25.0°C; 1 to 45°F) set point differential. Compressor Cut-IN is $T > SET + HY$. Compressor Cut-OUT is $T \leq SET$.
HYE	Compressor regulation differential in energy saving mode: (0.1 to 25.0°C; 1 to 45°F) set point differential. Compressor Cut-IN is $T > SET + HES + HYE$. Compressor Cut-OUT is $T \leq SET + HES$.
odS	Output activation delay at start-up: (0 to 255 min) this function is enabled after the instrument power-on and delays the output activations.
AC	Anti-short cycle delay: (0 to 50 min) minimum interval between a compressor stop and the following restart.
rtr	Regulation percentage=F(P1; P2) (100=P1; 0=P2): 100=P1 only; 0=P2 only
CCt	Maximum duration for Pull Down: (0.0 to 23h50min, res. 10min) after elapsing this interval of time, the super cooling function is immediately stopped
CCS	Pull Down phase differential (SET+CCS or SET+HES+CCS): (-12.0 to 12.0°C; -21 to 21°F) during any super cooling phase the regulation SETPOINT is moved to SET+CCS (in normal mode) or to SET+HES+CCS (in energy saving mode)
oHt	Threshold for automatic activation of Pull Down in normal mode (SET+HY+oHt): (1.0 to 12.0°C; 1 to 21°F) this is the upper limit used to activate the super cooling function.
oHE	Threshold for automatic activation of Pull Down in energy saving mode (SET+HES+HYE+oHE): (1.0 to 12.0°C; 1 to 21°F) this is the upper limit used to activate the super cooling function.

Con	Compressor ON time with faulty probe: (0 to 255 min) time during which the compressor is active in case of faulty thermostat probe. With CY=0 compressor is always OFF.
CoF	Compressor OFF time with faulty probe: (0 to 255 min) time during which the compressor is OFF in case of faulty thermostat probe. With Cn=0 compressor is always active.

5.1.2 Probe configuration parameters – Prb

ot	Probe P1 calibration: (-12.0 to 12.0°C; -21 to 21°F) allows to adjust any possible offset of the first probe.
P2P	Probe P2 presence: n = not present; Y = present.
oE	Probe P2 calibration: -12.0 to 12.0°C; -21 to 21°F) allows to adjust any possible offset of the second probe.
P3P	Probe P3 presence: n = not present; Y = the defrost present.
o3	Probe P3 calibration: (-12.0 to 12.0°C; -21 to 21°F) allows to adjust any possible offset of the third probe.
P4P	Probe P4 presence: n = not present; Y = present.
o4	Probe P4 calibration: (-12.0 to 12.0°C; -21 to 21°F) allows to adjust any possible offset of the forth probe.

5.1.3 Visualization parameters - diS

CF	Temperature measurement unit: (°C; °F) °C = Celsius; °F = Fahrenheit.
rES	Temperature resolution: (dE; in) dE = decimal; in = integer.
Lod	Probe default displayed: (P1; P2; P3; P4; SEt; dtr; USr) Px=probe “x”; SEt=set point; dtr=do not use it.
rEd	Remote probe displayed (for XH-REP): (P1; P2; P3; P4; SEt; dtr; USr) Px=probe “x”; SEt=set point; dtr=do not use it.
dLY	Temperature display delay: (0.0 to 20min00sec, res. 10 sec) when the temperature increases, the display is updated of 1°C or 1°F after this time.
dtr	Probe visualization percentage, F(P1; P2): (0 to 100) with dtr=1 the display will show this value VALUE=0.01*P1+0.99*P2

5.1.4 Defrost configuration parameters - dEF

EdF	Defrost mode: in=fixed intervals; rtC=following real time clock
tdF	Defrost type: EL=electrical heaters; in=hot gas;
dFP	Probe selection for defrost control: (nP; P1; P2; P3; P4) nP=no probe; Px=probe “x”. Note: P4=Probe on Hot Key plug.
dtE	End defrost temperature: (-55 to 50°C; -67 to 122°F) sets the temperature measured by the evaporator probe (dFP), which causes the end of defrost cycle.
idF	Interval between two successive defrost cycles: (0 to 255 hours) determines the time interval between the beginning of two defrosting cycles.
MdF	Maximum length of defrost cycle: (0 to 255 min; 0 means no defrost) when P2P=n (no evaporator probe presence) it sets the defrost duration, when P2P=Y (defrost end based on evaporator temperature) it sets the maximum length for the defrost cycle.
dSd	Start defrost delay: (0 to 255 min) delay in defrost activation.
StC	Compressor stop before starting any defrost: (0 to 900 sec) interval with compressor OFF before activating hot gas cycle
dFd	Display during defrost: (rt; it; SP; dF) rt = real temperature; it = start defrost temperature; SP = SET-POINT; dF = label “dF”.
dAd	Temperature display delay after any defrost cycle: (0 to 255 min) delay before updating the temperature on the display after the end of any defrost.
Fdt	Draining time: (0 to 255 min) regulation delay after finishing a defrost phase
Hon	Drain heater enabled after draining time (par. Fdt): (0 to 255 min) the relative output will stay on after draining time.
dPo	Defrost cycle enabled at stat-up: (n; Y) enables defrost at power on.
HYP	Differential temperature during any pre-defrost phase: (-12.0 to 12.0°C; -21 to 21°F)
Pd2	Defrost output deactivation delay: (0 to 255 sec)
dAF	Pre-defrost time: (0 to 255 min)
od1	Automatic defrost (at the beginning of any energy saving mode): (n; Y) n=function disabled; Y=function enabled

od2	Optimized defrost: (n;Y) n = function disabled; Y = the controller needs a temperature probe placed on the evaporator surface to monitor the presence of ice during any defrost phase.
dSt	Temperature sampling time during an optimized defrost (valid only if od2=yes): (1 to 255 sec) interval used to analyze the evaporator temperature and define the defrost phase
SYd	Type of synchronized defrost: (n; SYn; nSY) n = function disabled; SYn = synchronized, all devices connected will start a defrost phase at the same time. nSY = de-synchronized, all devices connected will delay the beginning of the same defrost phase.
dt1	Differential temperature for latent heating control (0.1 to 1.0 °C) to catch the latent heating phase during any defrost
ErS	Restart regulation after dripping time, when defrost Syd = nSY: n = disabled; Y = enabled
ndE	Number of devices connected to the virtual network for random defrost (valid if Syd=rnd): (1 to 20) number of devices connected to the same network for syncro or desyncro defrost.

5.1.5 Evaporator and condenser fan configuration parameters - FAn

FAP	Probe selection for evaporator fan: (nP; P1; P2; P3; P4) nP =no probe; Px =probe "x". Note: P4 =Probe on Hot Key plug.
FSt	Evaporator fan stop temperature: (-55 to 50°C; -67 to 122°F) setting of temperature, detected by evaporator probe. Above this temperature value fans are always OFF. NOTE: it works only for the evaporator fan, NOT for the condenser fan.
HYF	Evaporator fan regulator differential: (0.1 to 25.5°C; 1 to 45°F) evaporator fan will stop when the measured temperature (from FAP) is T<FSt-HYF.
FnC	Evaporator fan operating mode: (Cn; on; CY; oY) <ul style="list-style-type: none"> Cn = runs with the compressor, duty-cycle when compressor is OFF (see FoF, Fon, FF1 and Fo1 parameters) and OFF during defrost on = continuous mode, OFF during defrost CY = runs with the compressor, duty-cycle when compressor is OFF (see FoF, Fon, FF1 and Fo1 parameters) and ON during defrost oY = continuous mode, ON during defrost
Fnd	Evaporator fan delay after defrost cycle: (0 to 255 min) delay before fan activation after any defrosts.
FCt	Differential for cyclic activation of evaporator fans: (0 to 50°C)
FSU	Evaporator fan operating mode: (Std; Fon; FoF) Std = standard mode, evaporator fan uses par FnC ; Fon = evaporator Fan always on; FoF = evaporator fan always off.
Ft	Evaporator fan controlled during defrost: (n; Y) n = evaporator fan uses par. FnC during any defrost; Y = evaporator fan regulator is active during any defrost.
Fon	Evaporator fan ON time in normal mode (with compressor OFF): (0 to 255 min) used when energy saving status is not active.
FoF	Evaporator fan OFF time in normal mode (with compressor OFF): (0 to 255 min) used when energy saving status is not active.
Fo1	Evaporator fan ON time in energy saving mode (with compressor OFF) (0 to 255 min) used when energy saving status is active.
FF1	Evaporator fan OFF time in energy saving mode (with compressor OFF): (0 to 255 min) used when energy saving status is active.
Fd1	Evaporator fan delay: (0 to 255 sec) delay before activating evaporator fan
Fd2	Evaporator fan delay after closing door: (0 to 255 sec) delay before activating evaporator fan and after closing the door
FAC	Probe selection for condenser fan: (nP; P1; P2; P3; P4) nP =no probe; Px =probe "x". Note: P4 =Probe on Hot Key plug.
St2	Set Point 2 regulation (for condenser fan): (-55 to 50°C; -67 to 122°F) setting of temperature detected by evaporator probe. Above this value of temperature fans are always OFF.
HY2	Set Point 2 differential (for condenser fan): (0.1 to 25.5°C; 1 to 45°F) differential for evaporator ventilator regulator
FCC	Condenser fan operating mode: (Cn; on; CY; oY) <ul style="list-style-type: none"> Cn = runs with the compressor and OFF during defrost on = continuous mode, OFF during defrost CY = runs with the compressor and ON during defrost oY = continuous mode, ON during defrost
Fd3	Condenser fan activation delay: (0 to 255 sec) delay before activating condenser fan
Fd4	Condenser fan deactivation delay: (0 to 255 sec) delay before deactivating condenser fan

5.1.6 Auxiliary regulator parameters - AUS

ACH	Type of control for auxiliary regulator: (Ht; CL) Ht = heating; CL = cooling.
SAA	Set Point for auxiliary regulator: (-55.0 to 150.0°C; -67 to 302°F) it defines the room temperature set point to switch auxiliary relay.
SHY	Auxiliary regulator differential: (0.1 to 25.5°C; 1 to 45°F) differential for auxiliary output set point. <ul style="list-style-type: none"> • ACH=CL, AUX Cut in is [SAA+SHY]; AUX Cut out is SAA. • ACH=Ht, AUX Cut in is [SAA-SHY]; AUX Cut out is SAA.
ArP	Probe selection for auxiliary regulator: (nP; P1; P2; P3; P4) nP = no probe, the auxiliary relay is switched only by the digital input; Px =probe "x". Note: P4 =Probe on Hot Key plug.
Sdd	Auxiliary regulator disabled during any defrost cycle: (n; Y) n = the auxiliary relay operates during defrost. Y = the auxiliary relay is switched off during defrost.
btA	Base time for parameters Ato and AtF: (SEC; Min) SEC = base time is in second; Min = base time is in minutes.
Ato	Interval of time with auxiliary output ON: 0 to 255 (base time defined in par. btA)
AtF	Interval of time with auxiliary output OFF: 0 to 255 (base time defined in par. btA)

5.1.7 Alarm configuration parameters

ALP	Probe selection for temperature alarms: (nP; P1; P2; P3; P4) nP =no probe; Px =probe "x". Note: P4 =Probe on Hot Key plug.
ALC	Temperature alarms configuration: (Ab, rE) Ab = absolute; rE = relative.
ALU	High temperature alarm: when this temperature is reached, the alarm is enabled after the Ad delay time. <ul style="list-style-type: none"> • If ALC=Ab → ALL to 150.0°C or ALL to 302°F. • If ALC=rE → 0.0 to 50.0°C or 0 to 90°F.
ALL	Low temperature alarm: when this temperature is reached, the alarm is enabled after the Ad delay time. <ul style="list-style-type: none"> • If ALC=Ab → -55.0°C to ALU or -67°F to ALU. • If ALC=rE → 0.0 to 50.0°C or 0 to 90°F.
AFH	Temperature alarm differential: (0.1 to 25.0°C; 1 to 45°F) alarm differential.
ALd	Temperature alarm delay: (0 to 255 min) delay time between the detection of an alarm condition and the relative alarm signalling.
dot	Temperature alarm delay with open door: (0.0 to 24h00min, res. 10 min) delay time between the detection of a temperature alarm condition and the relative alarm signalling, after starting up the instrument.
dAo	Temperature alarm delay at start-up: (0.0 to 24h00min, res. 10 min) delay time between the detection of a temperature alarm condition and the relative alarm signalling, after starting up the instrument.
AP2	Probe selection for second temperature alarm: (nP; P1; P2; P3; P4) nP =no probe; Px =probe "x". Note: P4 =Probe on Hot Key plug.
AU1	Pre-alarm threshold for second temperature alarm (absolute value): (-55.0 to 150.0°C; -67 to 302°F)
AH1	Second high temperature pre-alarm differential: (0.1 to 25.0°C; 1 to 45°F)
Ad1	Second high temperature pre-alarm delay: (0 to 255 min; 255 = not used) delay time between the detection of a condenser pre-alarm condition and the relative alarm signalling.
AL2	Second low temperature alarm: (-55.0 to 150.0°C; -67 to 302°F)
AU2	Second high temperature alarm: (-55.0 to 150.0°C; -67 to 302°F)
AH2	Second temperature alarm differential: (0.1 to 25.0°C; 1 to 45°F)
Ad2	Second temperature alarm delay: (0 to 255 min; 255 = not used) delay time between the detection of a condenser alarm condition and the relative alarm signalling.
dA2	Second temperature alarm delay at start-up: (0.0 to 24h00min, res. 10 min)
bLL	Compressor off due to second low temperature alarm: (n; Y) n = no, the compressor continues to work; Y = yes, the compressor is switched off while the alarm is ON; in any case, the regulation restarts after AC time at minimum.
AC2	Compressor off due to second high temperature alarm: (n; Y) n = no, the compressor continues to work; Y = yes, the compressor is switched off while the alarm is ON; in any case, the regulation restarts after AC time at minimum.
SAF	Differential for anti-freezing control: (-12.0 to 12.0°C; -21.0 to 21.0°F) the regulation stops if $T < SET + SAF$

tbA	Alarm relay deactivation: (n; Y) n = no, it is not possible to deactivate neither the buzzer nor any digital output set as an alarm; Y = yes, it is possible to deactivate both the buzzer and the digital output set as an alarm.
------------	---

5.1.8 Digital and analogue output configuration parameters - out

oAx (x=2, 3, 4)	Relay output oAx configuration: (nu; CP1; dEF; FAn; ALr; LiG; AUS; db; onF; HES; Cnd) nu=not used; CP1=compressor; dEF=defrost; FAn=ventilators; ALr=alarm; LiG=light; AUS=auxiliary relay; onF=always ON with instrument ON; db=neutral zone; HES=night blinds; Cnd=condenser fan; CP2=second compressor; dF2=second defrost; HET=heater control; inV=do not use it.
AoP	Alarm relay polarity: (oP; CL) oP = alarm activated by closing the contact; CL = alarm activated by opening the contact

5.1.9 Digital input configuration parameters - inP

ibt	Base time for digital inputs: (SEC; Min) SEC = seconds; Min = minutes. Delay in activating the function linked to the digital inputs.
i1P	Digital input 1 polarity: (oP; CL) oP = activated by closing the contact; CL = activated by opening the contact.
i1F	Digital input 1 configuration: (nu; dor; dEF; AUS; ES; EAL; bAL; PAL; FAn; HdF; onF; LiG; CC; EMt) <ul style="list-style-type: none"> • nu=not used • dor = door switch function • dEF = defrost activation • AUS = auxiliary output • ES = energy saving mode activation • EAL = external warning alarm • bAL = external lock alarm • PAL = external pressure alarm • FAn = evaporator fan control • HdF = holiday defrost • onF = ON/OFF status change • LiG = light output control • CC = change configuration (between C1 and C2) • EMt = do not use it
did	Digital inputs 1 alarm delay (base time depends on par. ibt): (0 to 255) delay between the detection of an external event and the activation of the relative function.
i2P	Digital input 2 polarity: (oP; CL) oP = activated by closing the contact; CL = activated by opening the contact.
i2F	Digital input 2 configuration: (nu; dor; dEF; AUS; ES; EAL; bAL; PAL; FAn; HdF; onF; LiG; CC; EMt) <ul style="list-style-type: none"> • nu = not used • dor = door switch function • dEF = defrost activation • AUS = auxiliary output • ES = energy saving mode activation • EAL = external warning alarm • bAL = external lock alarm • PAL = external pressure alarm • FAn = evaporator fan control • HdF = holiday defrost • onF = ON/OFF status change • LiG = light output control • CC = change configuration (between C1 and C2) • EMt = Motion detector
d2d	Digital inputs 2 alarm delay (base time depends on par. ibt): (0 to 255) delay between the detection of an external event and the activation of the relative function.
nPS	Number of external pressure switch alarms before stopping the regulation: (0 to 15) after reaching nPS events in the digital input alarm delay (par. dxd), the regulation will be stopped and a manual restart (ON/OFF, power OFF and power ON) will be required
odC	Compressor and fan status after door opening: (no; FAn; CPr; F-C): no = normal; FAn = Fans OFF; CPr = Compressor OFF; F-C = Compressor and fans OFF.

rrd	Regulation restart after door alarm: (n; Y) n = no regulation if the door is open; Y = when the rrd timer elapses, the regulation restarts even if a open door alarm is ON.
------------	--

5.1.10 Energy saving configuration parameters - ES

ErA	Energy saving algorithm: (nu; bAS) nu=disabled, the energy saving mode activation is by button, real time clock or digital input; bAS =basic algorithm, the energy saving mode activation depends on the the digital input.
HES	Energy saving mode temperature differential: (-30.0 to 30.0°C; -54 to 54°F) sets the increasing value of the set point during the Energy Saving cycle.
LdE	Energy saving controls the lights (lights OFF when energy saving is active): (n; Y) lights off when energy saving mode is active
StE	Period to switch from normal mode to energy saving mode: (0.0 to 24h00min, res. 10 min) if the door stay closed for StE time, the energy saving mode will be activated. NOTE: this will require a door switch to work.
EtS	Period to switch from energy saving mode to normal mode: (0.0 to 24h00min, res. 10 min) maximum time for energy saving mode. NOTE: this will require a door switch to work.
dS	Door opening time to switch from EtS to StE: (0 to 999 sec) the energy saving mode will be immediately deactivated as soon as the door stays open more than the dS time. NOTE: this will require a door switch to work.

5.1.11 Counters, read only values - Cnt

n1H	Number of activations for relay output oA1 (thousands of)
n1L	Number of activations for relay output oA1 (units of)
n2H	Number of activations for relay output oA2 (thousands of)
n2L	Number of activations for relay output oA2 (units of)
n3H	Number of activations for relay output oA3 (thousands of)
n3L	Number of activations for relay output oA3 (units of)
n4H	Number of activations for relay output oA4 (thousands of)
n4L	Number of activations for relay output oA4 (units of)
n5H	Number of total activation of digital input 1 (thousand of)
n5L	Number of total activation of digital input 1 (units of)
n6H	Number of total activation of digital input 2 (thousand of)
n6L	Number of total activation of digital input 2 (units of)
F1H	Number of working hours for relay output oA1 (thousands of)
F1L	Number of working hours for relay output oA1 (units of)
F2H	Number of working hours for relay output oA2 (thousands of)
F2L	Number of working hours for relay output oA2 (units of)
F3H	Number of working hours for relay output oA3 (thousands of)
F3L	Number of working hours for relay output oA3 (units of)
F4H	Number of working hours for relay output oA4 (thousands of)
F4L	Number of working hours for relay output oA4 (units of)

5.1.12 Real Time Clock configuration parameters - rtC

Hur	Hours: 0 to 23 hours
Min	Minutes: 0 to 59 minutes
dAY	Day of the week: Sun to Sat
dYM	Day of the month: 1 to 31
Mon	Month: 1 to 12
YAr	Year: 00 to 99
Hd1	First day of weekend: (Sun to SAT; nu) setting for the first day of the weekend.
Hd2	Second day of weekend: (Sun to SAT; nu) setting for the second day of the weekend.
iLE	Energy saving cycle start time on working days: (00h00min to 23h50min) during the Energy Saving cycle, the set point is increased by the value in HES so that the operation set point is SET+HES .
dLE	Energy saving cycle duration on working days: (00h00min to 24h00min) sets the duration of the Energy Saving cycle on working days.
iSE	Energy saving cycle start time on weekends: 00h00min to 23h50min
dSE	Energy saving cycle duration on weekends: 00h00min to 24h00min

ddx	<p>Daily defrost enabled: (n; Y) to enable the Ld1 to Ld6 defrost operations for any day of the week.</p> <ul style="list-style-type: none"> • dd1 = Sunday defrost • dd2 = Monday defrost • dd3 = Tuesday defrost • dd4 = Wednesday defrost • dd5 = Thursday defrost • dd6 = Friday defrost • dd7 = Saturday defrost
Ldx	<p>Defrost start time: (00h00min to 23h50min) these parameters set the beginning of the programmable defrost cycles during any ddx day. Example: when Ld2=12.4, the second defrost starts at 12:40 am during working days.</p>

5.1.13 Memory storage management – E2

MAP	Current configuration: (C-1; C-2) to change configuration used.
LdM	Restore default factory settings: (n;Y) select Y and confirm to reload factory default values for the configuration currently used.
rHA	Reset HACCP values: (n; Y) select Y and confirm to reset the memorized min and MAX temperature values (HACCP function must be enabled).

5.1.14 Serial Communication port configuration parameters - CoM

Adr	Serial address: (1 to 247) device address for Modbus communication
bAU	Baudrate: (9.6; 19.2; 38.4; 57.6) select the correct baudrate for serial communication
PAr	Parity control: (no; odd; EvE) no=no parity control; odd=odd parity control; EvE=even parity control

5.1.15 User Interface configuration parameters - Ui

SCS	User interface timeout: (1 to 255 sec) timeout before coming back to Home Screen or to Programming Menu
bS	Sound Level: (0 to 5) select the sound level of the gestures
PSU	Password for protected level Pr2: (000 to 999) insert a value to protect all the parameters set on the level Pr2 from modification

5.1.16 Information, read only parameters - inF

dP1	Probe P1 value visualization
dP2	Probe P2 value visualization
dP3	Probe P3 value visualization
dP4	Probe P4 value visualization
rSE	Real regulation Set Point
FdY	Firmware release date: day
FMt	Firmware release date: month
FYr	Firmware release date: year
rEL	Firmware release: progressive number
SUb	Firmware sub release: progressive number
Ptb	Parameter map version

NOTE: some parameters are not present in models XR30T and XR60T due to lack of the relevant I/O's.

5.2 PARAMETER CONFIGURATION 1

Group	Par.	Description	Value	Protected	U.O.M.	Range
rEG	SEt	Set Point	3.0	Pr1	°C	LS to US
rEG	LS	Minimum Set point	-100.0	Pr1	°C	[-100.0°C to SET] [-148.0°F to SET]
rEG	US	Maximum Set point	150.0	Pr1	°C	[SET to 150.0°C] [SET to 302.0°F]
rEG	HY	Compressor regulation differential in normal mode	3.0	Pr1	°C	[0.1°C to 25.0°C] [0.1°F to 45.0°F]
rEG	HYE	Compressor regulation differential in energy saving mode	3.0	Pr1	°C	[0.1°C to 25.0°C] [0.1°F to 45.0°F]

rEG	odS	Output activation delay at start-up	0	Pr1	min	0 to 255 min
rEG	AC	Anti-short cycle delay	0	Pr1	min	0 to 50 min
rEG	rtr	Regulation percentage=F(P1; P2) (100=P1; 0=P2)	100	Pr2		0 to 100
rEG	CCt	Maximum duration for Pull Down	00:00	Pr2	hh:mm	0 to 23h50min
rEG	CCS	Pull Down phase differential (SET+CCS or SET+HES+CCS)	0.0	Pr2	°C	[-12.0°C to 12.0°C] [-21.6°F to 21.6°F]
rEG	oHt	Threshold for automatic activation of Pull Down in normal mode (SET+HY+oHt)	10.0	Pr2	°C	[0.0°C to 25.0°C] [0.0°F to 45.0°F]
rEG	oHE	Threshold for automatic activation of Pull Down in energy saving mode (SET+HES+HYE+oHE)	10.0	Pr2	°C	[0.0°C to 25.0°C] [0.0°F to 45.0°F]
rEG	Con	Compressor ON time with faulty probe	10	Pr1	min	0 to 255 min
rEG	CoF	Compressor OFF time with faulty probe	15	Pr1	min	0 to 255 min
Prb	ot	Probe P1 calibration	0.0	Pr1	°C	[-12.0°C to 12.0°C] [-21.6°F to 21.6°F]
Prb	P2P	Probe P2 presence	Y	Pr1		n(0); Y(1)
Prb	oE	Probe P2 calibration	0.0	Pr1	°C	[-12.0°C to 12.0°C] [-21.6°F to 21.6°F]
Prb	P3P	Probe P3 presence	no	Pr1		n(0); Y(1)
Prb	o3	Probe P3 calibration	0.0	Pr1	°C	[-12.0°C to 12.0°C] [-21.6°F to 21.6°F]
Prb	P4P	Probe P4 presence	no	Pr1		n(0); Y(1)
Prb	o4	Probe P4 calibration	0.0	Pr1	°C	[-12.0°C to 12.0°C] [-21.6°F to 21.6°F]
diS	CF	Temperature measurement unit: Celsius; Fahrenheit	°C	Pr1		°C(0); °F(1)
diS	rES	Temperature resolution: decimal, integer	dE	Pr1		dE(0); in(1)
diS	Lod	Probe default displayed	P1	Pr1		P1(0); P2(1); P3(2); P4(3); SEt(4); dtr(5)
diS	dLy	Temperature display delay (resolution 10 sec)	00:00	Pr1	mm:ss	0.0 to 20min00sec
diS	dtr	Probe visualization percentage=F(P1;P2) (ex: dtr=1 means VALUE=0.01*P1+0.99*P2)	99	Pr1		1 to 99
dEF	EdF	Defrost mode	rtC	Pr2		rtC(0); in(1)
dEF	tdF	Defrost type: electric heating, hot gas	EL	Pr2		EL(0); in(1)
dEF	dFP	Probe selection for defrost control	P2	Pr2		nP(0); P1(1); P2(2); P3(3); P4(4)
dEF	dtE	End defrost temperature	8.0	Pr2	°C	[-50.0°C to 50.0°C] [-58.0°F to 122.0°F]
dEF	idF	Interval between two successive defrost cycles	24	Pr2	ora	0 to 255 hours
dEF	MdF	Maximum length of defrost cycle	20	Pr2	min	0 to 255 min
dEF	dSd	Start defrost delay	0	Pr2	sec	0 to 255 sec
dEF	StC	Compressor stop before starting any defrost	0	Pr2	sec	0 to 255 sec
dEF	dFd	Displaying during defrost	dEF	Pr2		rt(0); it(1); SEt(2); dEF(3); Coo(4)
dEF	dAd	Temperature display delay after any defrost cycle	0	Pr2	min	0 to 255 min
dEF	Fdt	Draining time	1	Pr2	min	0 to 255 min
dEF	Hon	Drain heater enabled after draining time (par. Fdt)	2	Pr2	min	0 to 255 min
dEF	dPo	Defrost cycle enabled at stat-up	no	Pr2		n(0); Y(1)
dEF	od1	Automatic defrost (at the beginning of any energy saving mode)	no	Pr2		n(0); Y(1)
dEF	od2	Optimized defrost	no	Pr2		n(0); Y(1)

dEF	dSt	Temperature sampling time during an optimized defrost (valid only if od2=yes)	30	Pr2	sec	1 to 255 sec
dEF	SYd	Type of synchronized defrost	nU	Pr2		nu(0); SYn(1); nSY(2)
dEF	dt1	Differential temperature for latent heating control	0.1	Pr2	°C	0.1 to 1.0°C
dEF	ErS	Restart regulation after dripping time, when defrost Syd = nSY	no	Pr2		n(0); Y(1)
FAn	FAP	Probe selection for evaporator fan	P2	Pr2		nP(0); P1(1); P2(2); P3(3); P4(4)
FAn	FSt	Evaporator fan stop temperature	10.0	Pr2	°C	[-50.0°C to 50.0°C] [-58.0°F to 122.0°F]
FAn	HYF	Evaporator fan regulator differential	2.0	Pr2	°C	[0.1°C to 25.0 °C] [0.1°F to 45.0°F]
FAn	FnC	Evaporator fan operating mode	C_n	Pr2		C-n(0); O-n(1); C-Y(2); O-Y(3)
FAn	Fnd	Evaporator fan delay after defrost cycle	1	Pr2	min	0 to 255 min
FAn	FCt	Differential temperature for cyclic activation of evaporator fans (o=disabled)	0	Pr2	°C	[0°C to 50°C] [0°F to 90°F]
FAn	FSU	Evaporator fan operating mode	Std	Pr2		Std(0); FoF(1); Fon(2)
FAn	Ft	Evaporator fan controlled during defrost	no	Pr2		n(0); Y(1)
FAn	Fon	Evaporator fan ON time in normal mode (with compressor OFF)	5	Pr2	min	0 to 255 min
FAn	FoF	Evaporator fan OFF time in normal mode (with compressor OFF)	10	Pr2	min	0 to 255 min
FAn	Fo1	Evaporator fan ON time in energy saving mode (with compressor OFF)	5	Pr2	min	0 to 255 min
FAn	FF1	Evaporator fan OFF time in energy saving mode (with compressor OFF)	10	Pr2	min	0 to 255 min
FAn	Fd1	Evaporator fan delay	0	Pr2	sec	0 to 255 sec
FAn	Fd2	Evaporator fan delay after closing door	0	Pr2	sec	0 to 255 sec
FAn	FAC	Probe selection for condenser fan	P3	Pr2		nP(0); P1(1); P2(2); P3(3); P4(4)
FAn	St2	Set Point 2 regulation (for condenser fan)	10.0	Pr2	°C	[-100.0°C to 150.0°C] [-148.0°F to 302.0°F]
FAn	Hy2	Set Point 2 differential (for condenser fan)	10.0	Pr2	°C	[0.1°C to 25.0°C] [0.1°F to 45.0°F]
FAn	FCC	Condenser fan operating mode	C_n	Pr2		C-n(0); O-n(1); C-Y(2); O-Y(3)
FAn	Fd3	Condenser fan activation delay	0	Pr2	sec	0 to 255 sec
FAn	Fd4	Condenser fan deactivation delay	0	Pr2	sec	0 to 255 sec
AUS	ACH	Type of control for auxiliary regulator	CL	Pr2		CL(0); Ht(1)
AUS	SAA	Set point for auxiliary regulator	5.0	Pr2	°C	[-100.0°C to 150.0°C] [-148.0°F to 302.0°F]
AUS	SHy	Auxiliary regulator differential	2.0	Pr2	°C	[0.1°C to 25.0°C] [0.1°F to 45.0°F]
AUS	ArP	Probe selection for auxiliary regulator	nP	Pr2		nP(0); P1(1); P2(2); P3(3); P4(4)
AUS	Sdd	Auxiliary regulator disabled during any defrost cycle	no	Pr2		n(0); Y(1)
AUS	btA	Base time for parameters Ato and AtF	SEC	Pr2		SEC; Min
AUS	Ato	Interval of time with auxiliary output ON	0	Pr2	sec	0 to 255 sec/min
AUS	AtF	Interval of time with auxiliary output OFF	0	Pr2	sec	0 to 255 sec/min
ALr	ALP	Probe selection for temperature alarms	P1	Pr1		nP(0); P1(1); P2(2); P3(3); P4(4)
ALr	ALC	Temperature alarms configuration: relative, absolute	Ab	Pr1		rE(0); Ab(1)
ALr	ALU	High temperature alarm	150.0	Pr1	°C	°C[0.0° to 50.0° or ALL to 150.0°] °F[0.0° to 90.0° or ALL to 302.0°]
ALr	ALL	Low temperature alarm	-100.0	Pr1	°C	°C[0.0° to 50.0° or -100.0° to ALU] °F[0.0° to 90.0° or -148.0° to ALU]

ALr	AFH	Temperature alarm differential	2.0	Pr1	°C	[0.1°C to 25.0°C] [0.1°F to 45.0°F]
ALr	ALd	Temperature alarm delay	0	Pr1	min	0 to 255 min
ALr	dot	Temperature alarm delay with open door	00:00	Pr1	mm:ss	0.0 to 24min00sec
ALr	dAo	Temperature alarm delay at start-up	00:00	Pr1	hh:mm	0.0 to 24h00min
ALr	AP2	Probe selection for second temperature alarm	P2	Pr2		nP(0); P1(1); P2(2); P3(3); P4(4)
ALr	AU1	Pre-alarm threshold for second temperature alarm (absolute value)	150.0	Pr2	°C	[-100.0°C to 150.0°C] [-148.0°F to 302.0°F]
ALr	AH1	Second high temperature pre-alarm differential	2.0	Pr2	°C	[0.1°C to 25.0°C] [0.1°F to 45.0°F]
ALr	Ad1	Second high temperature pre-alarm delay	255	Pr2	min	0 to 255 min
ALr	AL2	Second low temperature alarm	-100.0	Pr2	°C	[-100.0°C to 150.0°C] [-148.0°F to 302.0°F]
ALr	AU2	Second high temperature alarm	150.0	Pr2	°C	[-100.0°C to 150.0°C] [-148.0°F to 302.0°F]
ALr	AH2	Second temperature alarm differential	2.0	Pr2	°C	[0.1°C to 25.0°C] [0.1°F to 45.0°F]
ALr	Ad2	Second temperature alarm delay	0	Pr2	min	0 to 255 min
ALr	dA2	Second temperature alarm delay at start-up	00:00	Pr2	hh:mm	0.0 to 24h00min
ALr	bLL	Compressor OFF due to second low temperature alarm	no	Pr2		n(0); Y(1)
ALr	AC2	Compressor OFF due to second high temperature alarm	n	Pr2		n(0); Y(1); MAn(2)
ALr	SAF	Differential for anti-freezing control	-1.0	Pr2	°C	[-12.0°C to 12.0°C] [-21.6°F to 21.6°F]
ALr	tbA	Alarm relay deactivation	no	Pr2		n(0); Y(1)
oUt	oA2	Relay output oA2 configuration	dEF	Pr2		nu(0); CP1(1); dEF(2); FAn(3); ALr(4); LiG(5); AUS(6); db(7); onF(8); HES(9); Cnd(10); CP2(11); dF2(12); HEt(13); inv(14)
oUt	oA3	Relay output oA3 configuration	FAn	Pr2		nu(0); CP1(1); dEF(2); FAn(3); ALr(4); LiG(5); AUS(6); db(7); onF(8); HES(9); Cnd(10); CP2(11); dF2(12); HEt(13); inv(14)
oUt	oA4	Relay output oA4 configuration	LiG	Pr2		nu(0); CP1(1); dEF(2); FAn(3); ALr(4); LiG(5); AUS(6); db(7); onF(8); HES(9); Cnd(10); CP2(11); dF2(12); HEt(13); inv(14)
oUt	AOP	Alarm relay polarity	CL	Pr2		oP(0); CL(1)
inP	ibt	Base times for digital inputs	SEC	Pr1		SEC(0); Min(1)
inP	i1P	Digital input 1 polarity	CL	Pr1		oP(0); CL(1)
inP	i1F	Digital input 1 configuration	dor	Pr1		nu(0); dor(1); dEF(2); AUS(3); ES(4); EAL(5); bAL(6); PAL(7); FAn(8); HdF(9); onF(10); LiG(11); CC(12); EMt(13)
inP	did	Digital input 1 alarm delay (base time depends on par. ibt)	0	Pr1	sec	0 to 255 min/sec
inP	i2P	Digital input 2 polarity	CL	Pr1		OP(0); CL(1)
inP	i2F	Digital input 2 configuration	EAL	Pr1		nu(0); dor(1); dEF(2); AUS(3); ES(4); EAL(5); bAL(6); PAL(7); FAn(8); HdF(9); onF(10); LiG(11); CC(12); EMt(13)
inP	d2d	Digital input 2 alarm delay (base time depends on par. ibt)	0	Pr1	sec	0 to 255 min/sec
inP	nPS	Number of external pressure switch alarms before stopping the regulation	0	Pr2		0 to 15

inP	odC	Compressor and fan status after door opening	no	Pr2		no(0); FAn(1); CPr(2); F-C(3)
inP	rrd	Regulation restart after door alarm	no	Pr2		n(0); Y(1)
ES	ErA	Energy saving algorithm	nu	Pr2		nu(0); bAS(1)
ES	HES	Energy saving mode temperature differential	0	Pr1	°C	[-30°C to 30°C] [-54°F to 54°F]
ES	LdE	Energy saving controls the lights (lights OFF when energy saving is active)	no	Pr1		n(0); Y(1)
ES	StE	Period to switch from normal mode to energy saving mode	00:00	Pr1	hh:mm	0 to 23h50min; nu
ES	EtS	Period to switch from energy saving mode to normal mode	00:00	Pr1	hh:mm	0 to 23h50min; nu
ES	dS	Door opening time to switch from EtS to StE	0	Pr1	sec	0 to 999 sec
Cnt	n1H	Number of activations for relay output oA1 (thousands of)		Pr1		read only
Cnt	n1L	Number of activations for relay output oA1 (units of)		Pr1		read only
Cnt	n2H	Number of activations for relay output oA2 (thousands of)		Pr1		read only
Cnt	n2L	Number of activations for relay output oA2 (units of)		Pr1		read only
Cnt	n3H	Number of activations for relay output oA3 (thousands of)		Pr1		read only
Cnt	n3L	Number of activations for relay output oA3 (units of)		Pr1		read only
Cnt	n4H	Number of activations for relay output oA4 (thousands of)		Pr1		read only
Cnt	n4L	Number of activations for relay output oA4 (units of)		Pr1		read only
Cnt	n5H	Number of total activations of digital input 1 (thousand of)		Pr1		read only
Cnt	n5L	Number of total activations of digital input 1 (units of)		Pr1		read only
Cnt	n6H	Number of total activations of digital input 2 (thousand of)		Pr1		read only
Cnt	n6L	Number of total activations of digital input 2 (units of)		Pr1		read only
Cnt	F1H	Number of working hours for relay output oA1 (thousands of)		Pr1	hours	read only
Cnt	F1L	Number of working hours for relay output oA1 (units of)		Pr1	hours	read only
Cnt	F2H	Number of working hours for relay output oA2 (thousands of)		Pr1	hours	read only
Cnt	F2L	Number of working hours for relay output oA2 (units of)		Pr1	hours	read only
Cnt	F3H	Number of working hours for relay output oA3 (thousands of)		Pr1	hours	read only
Cnt	F3L	Number of working hours for relay output oA3 (units of)		Pr1	hours	read only
Cnt	F4H	Number of working hours for relay output oA4 (thousands of)		Pr1	hours	read only
Cnt	F4L	Number of working hours for relay output oA4 (units of)		Pr1	hours	read only
rtC	Hur	Hours		Pr1		read only
rtC	Min	Minutes		Pr1		read only
rtC	dAY	Day of the week		Pr1		read only
rtC	dYM	Day of the month		Pr1		read only
rtC	Mon	Month		Pr1		read only
rtC	YAr	Year		Pr1		read only

rtC	Hd1	First day of weekend	nu	Pr2		Sun(0) to SAT(6); nu(7)
rtC	Hd2	Second day of weekend	nu	Pr2		Sun(0) to SAT(6); nu(7)
rtC	iLE	Energy saving cycle start time on working days	00:00	Pr2	hh:mm	0.0 to 23h50min
rtC	dLE	Energy saving cycle duration on working days	00:00	Pr2	hh:mm	0.0 to 24h00min
rtC	iSE	Energy saving cycle start time on weekends	00:00	Pr2	hh:mm	0.0 to 23h50min
rtC	dSE	Energy saving cycle duration on weekends	00:00	Pr2	hh:mm	0.0 to 24h00min
rtC	dd1	Sunday defrost	no	Pr2		n(0); Y(1)
rtC	dd2	Monday defrost	no	Pr2		n(0); Y(1)
rtC	dd3	Tuesday defrost	no	Pr2		n(0); Y(1)
rtC	dd4	Wednesday defrost	no	Pr2		n(0); Y(1)
rtC	dd5	Thursday defrost	no	Pr2		n(0); Y(1)
rtC	dd6	Friday defrost	no	Pr2		n(0); Y(1)
rtC	dd7	Saturday defrost	no	Pr2		n(0); Y(1)
rtC	Ld1	1st defrost start time	00:00	Pr2	hh:mm	0.0 to 23h50min(143); nu(144)
rtC	Ld2	2nd defrost start time	00:00	Pr2	hh:mm	0.0 to 23h50min(143); nu(144)
rtC	Ld3	3rd defrost start time	00:00	Pr2	hh:mm	0.0 to 23h50min(143); nu(144)
rtC	Ld4	4th defrost start time	00:00	Pr2	hh:mm	0.0 to 23h50min(143); nu(144)
rtC	Ld5	5th defrost start time	00:00	Pr2	hh:mm	0.0 to 23h50min(143); nu(144)
rtC	Ld6	6th defrost start time	00:00	Pr2	hh:mm	0.0 to 23h50min(143); nu(144)
E2	MAP	Current configuration	0	Pr1		C-1(0); C-2(1)
E2	LdM	Restore default factory setting	0	Pr2		n(0); Y(1)
E2	rHA	Reset for HACCP function	0	Pr2		n(0); Y(1)
CoM	Adr	Serial address	1	Pr2		1 to 247
CoM	BAU	Baudrate	9.6	Pr2		9.6(0); 19.2(1); 38.4(2); 57.6(3);
CoM	PAr	Parity control	no	Pr2		no(0); odd(1); EvE(2)
Ui	SCS	User interface timeout	60	Pr2	sec	1 to 255 sec
Ui	bS	Sound Level	3	Pr2		0 to 5
Ui	PSU	Password for protected level Pr2		Pr2		0 to 999
inF	dP1	Probe P1 value visualization		Pr1		read only
inF	dP2	Probe P2 value visualization		Pr1		read only
inF	dP3	Probe P3 value visualization		Pr1		read only
inF	dP4	Probe P4 value visualization		Pr1		read only
inF	rSE	Real regulation Set Point (SET + ES + SETd)		Pr1		read only
inF	FdY	Firmware release date: day		Pr1		read only
inF	FMn	Firmware release date: month		Pr1		read only
inF	FYr	Firmware release date: year		Pr1		read only
inF	rEL	Firmware release		Pr1		read only
inF	SUb	Firmware sub release		Pr1		read only
inF	Ptb	Parameter map version		Pr1		read only

NOTE: some parameters are not present in XR30T and XR60T models due to lack of the relevant I/O's.

5.3 PARAMETER CONFIGURATION 2

Group	Parameter	Description	Value	Protected	U.O.M.	Range
rEG	SEt	Set Point	38.0	Pr1	°F	LS to US
rEG	LS	Minimum Set point	-148.0	Pr1	°F	[-100.0°C to SET] [-148.0°F to SET]
rEG	US	Maximum Set point	302.0	Pr1	°F	[SET to 150.0°C] [SET to 302.0°F]
rEG	HY	Compressor regulation differential in normal mode	6.0	Pr1	°F	[0.1°C to 25.0°C] [0.1°F to 45.0°F]
rEG	HYE	Compressor regulation differential in energy saving mode	6.0	Pr1	°F	[0.1°C to 25.0°C] [0.1°F to 45.0°F]
rEG	odS	Output activation delay at start-up	0	Pr1	min	0 to 255 min
rEG	AC	Anti-short cycle delay	0	Pr1	min	0 to 50 min
rEG	rtr	Regulation percentage=F(P1; P2) (100=P1; 0=P2)	100	Pr2		0 to 100
rEG	CCt	Maximum duration for Pull Down	00:00	Pr2	hh:mm	0 to 23h50min
rEG	CCS	Pull Down phase differential (SET+CCS or SET+HES+CCS)	0.0	Pr2	°F	[-12.0°C to 12.0°C] [-21.6°F to 21.6°F]
rEG	oHt	Threshold for automatic activation of Pull Down in normal mode (SET+HY+oHt)	20.0	Pr2	°F	[0.0°C to 25.0°C] [0.0°F to 45.0°F]
rEG	oHE	Threshold for automatic activation of Pull Down in energy saving mode (SET+HES+HYE+oHE)	20.0	Pr2	°F	[0.0°C to 25.0°C] [0.0°F to 45.0°F]
rEG	Con	Compressor ON time with faulty probe	10	Pr1	min	0 to 255 min
rEG	CoF	Compressor OFF time with faulty probe	15	Pr1	min	0 to 255 min
Prb	ot	Probe P1 calibration	0	Pr1	°F	[-12.0°C to 12.0°C] [-21.6°F to 21.6°F]
Prb	P2P	Probe P2 presence	Y	Pr1		n(0); Y(1)
Prb	oE	Probe P2 calibration	0	Pr1	°F	[-12.0°C to 12.0°C] [-21.6°F to 21.6°F]
Prb	P3P	Probe P3 presence	no	Pr1		n(0); Y(1)
Prb	o3	Probe P3 calibration	0	Pr1	°F	[-12.0°C to 12.0°C] [-21.6°F to 21.6°F]
Prb	P4P	Probe P4 presence	no	Pr1		n(0); Y(1)
Prb	o4	Probe P4 calibration	0	Pr1	°F	[-12.0°C to 12.0°C] [-21.6°F to 21.6°F]
diS	CF	Temperature measurement unit: Celsius; Fahrenheit	°F	Pr1		°C(0); °F(1)
diS	rES	Temperature resolution: decimal, integer	dE	Pr1		dE(0); in(1)
diS	Lod	Probe default displayed	P1	Pr1		P1(0); P2(1); P3(2); P4(3); SEt(4); dtr(5)
diS	dLy	Temperature display delay (resolution 10 sec)	00:00	Pr1	mm:ss	0.0 to 20min00sec
diS	dtr	Probe visualization percentage=F(P1;P2) (dtr=1 means VALUE=0.01*P1+0.99*P2)	99	Pr1		1 to 99
dEF	EdF	Defrost mode	rtC	Pr2		rtC(0); in(1)
dEF	tdF	Defrost type: electric heating, hot gas	EL	Pr2		EL(0); in(1)
dEF	dFP	Probe selection for defrost control	P2	Pr2		nP(0); P1(1); P2(2); P3(3); P4(4)
dEF	dtE	End defrost temperature	48.0	Pr2	°F	[-50.0°C to 50.0°C] [-58.0°F to 122.0°F]
dEF	idF	Interval between two successive defrost cycles	24	Pr2	ora	0 to 255 hours
dEF	MdF	Maximum length of defrost cycle	20	Pr2	min	0 to 255 min
dEF	dSd	Start defrost delay	0	Pr2	sec	0 to 255 sec
dEF	StC	Compressor stop before starting any defrost	0	Pr2	sec	0 to 255 sec
dEF	dFd	Displaying during defrost	dEF	Pr2		rt(0); it(1); SEt(2); dEF(3); Coo(4)

dEF	dAd	Temperature display delay after any defrost cycle	0	Pr2	min	0 to 255 min
dEF	Fdt	Draining time	1	Pr2	min	0 to 255 min
dEF	Hon	Drain heater enabled after draining time (par. Fdt)	2	Pr2	min	0 to 255 min
dEF	dPo	Defrost cycle enabled at stat-up	no	Pr2		n(0); Y(1)
dEF	od1	Automatic defrost (at the beginning of any energy saving mode)	no	Pr2		n(0); Y(1)
dEF	od2	Optimized defrost	no	Pr2		n(0); Y(1)
dEF	dSt	Temperature sampling time during an optimized defrost (valid only if od2=yes)	30	Pr2	sec	1 to 255 sec
dEF	SYd	Type of synchronized defrost	nU	Pr2		nu(0); SYn(1); nSY(2)
dEF	dt1	Differential temperature for latent heating control	0.1	Pr2	°C	0.1 to 1.0°C
dEF	ErS	Restart regulation after dripping time, when defrost Syd = nSY	no	Pr2		n(0); Y(1)
FAn	FAP	Probe selection for evaporator fan	P2	Pr2		nP(0); P1(1); P2(2); P3(3); P4(4)
FAn	FSt	Evaporator fan stop temperature	50.0	Pr2	°F	[-50.0°C to 50.0°C] [-58.0°F to 122.0°F]
FAn	HYF	Evaporator fan regulator differential	4.0	Pr2	°F	[0.1°C to 25.0°C] [0.1°F to 45.0°F]
FAn	FnC	Evaporator fan operating mode	C-n	Pr2		C-n(0); O-n(1); C-Y(2); O-Y(3)
FAn	Fnd	Evaporator fan delay after defrost cycle	1	Pr2	min	0 to 255 min
FAn	FCt	Differential temperature for cyclic activation of evaporator fans (o=disabled)	0	Pr2	°F	[0°C to 50°C] [0°F to 90°F]
FAn	FSU	Evaporator fan operating mode	Std	Pr2		Std(0); FoF(1); Fon(2)
FAn	Ft	Evaporator fan controlled during defrost	no	Pr2		n(0); Y(1)
FAn	Fon	Evaporator fan ON time in normal mode (with compressor OFF)	5	Pr2	min	0 to 255 min
FAn	FoF	Evaporator fan OFF time in normal mode (with compressor OFF)	10	Pr2	min	0 to 255 min
FAn	Fo1	Evaporator fan ON time in energy saving mode (with compressor OFF)	5	Pr2	min	0 to 255 min
FAn	FF1	Evaporator fan OFF time in energy saving mode (with compressor OFF)	10	Pr2	min	0 to 255 min
FAn	Fd1	Evaporator fan delay	0	Pr2	sec	0 to 255 sec
FAn	Fd2	Evaporator fan delay after closing door	0	Pr2	sec	0 to 255 sec
FAn	FAC	Probe selection for condenser fan	P3	Pr2		nP(0); P1(1); P2(2); P3(3); P4(4)
FAn	St2	Set Point 2 regulation (for condenser fan)	50.0	Pr2	°F	[-100.0°C to 150.0°C] [-148.0°F to 302.0°F]
FAn	Hy2	Set Point 2 differential (for condenser fan)	20.0	Pr2	°F	[0.1°C to 25.0°C] [0.1°F to 45.0°F]
FAn	FCC	Condenser fan operating mode	C-n	Pr2		C-n(0); O-n(1); C-Y(2); O-Y(3)
FAn	Fd3	Condenser fan activation delay	0	Pr2	sec	0 to 255 sec
FAn	Fd4	Condenser fan deactivation delay	0	Pr2	sec	0 to 255 sec
AUS	ACH	Type of control for auxiliary regulator	CL	Pr2		CL(0); Ht(1)
AUS	SAA	Set point for auxiliary regulator	38.0	Pr2	°F	[-100.0°C to 150.0°C] [-148.0°F to 302.0°F]
AUS	SHy	Auxiliary regulator differential	4.0	Pr2	°F	[0.1°C to 25.0°C] [0.1°F to 45.0°F]
AUS	ArP	Probe selection for auxiliary regulator	nP	Pr2		nP(0); P1(1); P2(2); P3(3); P4(4)
AUS	Sdd	Auxiliary regulator disabled during any defrost cycle	no	Pr2		n(0); Y(1)
AUS	btA	Base time for parameters Ato and AtF	SEC	Pr2		SEC; Min
AUS	Ato	Interval of time with auxiliary output ON	0	Pr2	sec	0 to 255 sec/min
AUS	AtF	Interval of time with auxiliary output OFF	0	Pr2	sec	0 to 255 sec/min

ALr	ALP	Probe selection for temperature alarms	P1	Pr1		nP(0); P1(1); P2(2); P3(3); P4(4)
ALr	ALC	Temperature alarms configuration: relative, absolute	Ab	Pr1		rE(0); Ab(1)
ALr	ALU	High temperature alarm	302.0	Pr1	°F	°C[0.0° to 50.0° or ALL to 150.0°] °F[0.0° to 90.0° or ALL to 302.0°]
ALr	ALL	Low temperature alarm	-100.0	Pr1	°F	°C[0.0° to 50.0° or -100.0° to ALU] °F[0.0° to 90.0° or -148.0° to ALU]
ALr	AFH	Temperature alarm differential	4.0	Pr1	°F	[0.1°C to 25.0°C] [0.1°F to 45.0°F]
ALr	ALd	Temperature alarm delay	0	Pr1	min	0 to 255 min
ALr	dot	Temperature alarm delay with open door	00:00	Pr1	mm:ss	0.0 to 24min00sec
ALr	dAo	Temperature alarm delay at start-up	00:00	Pr1	hh:mm	0.0 to 24h00min
ALr	AP2	Probe selection for second temperature alarm	P2	Pr2		nP(0); P1(1); P2(2); P3(3); P4(4)
ALr	AU1	Pre-alarm threshold for second temperature alarm (absolute value)	302.0	Pr2	°F	[-100.0°C to 150.0°C] [-148.0°F to 302.0°F]
ALr	AH1	Second high temperature pre-alarm differential	4.0	Pr2	°F	[0.1°C to 25.0°C] [0.1°F to 45.0°F]
ALr	Ad1	Second high temperature pre-alarm delay	255	Pr2	min	0 to 255 min
ALr	AL2	Second low temperature alarm	-148.0	Pr2	°F	[-100.0°C to 150.0°C] [-148.0°F to 302.0°F]
ALr	AU2	Second high temperature alarm	302.0	Pr2	°F	[-100.0°C to 150.0°C] [-148.0°F to 302.0°F]
ALr	AH2	Second temperature alarm differential	4.0	Pr2	°F	[0.1°C to 25.0°C] [0.1°F to 45.0°F]
ALr	Ad2	Second temperature alarm delay	0	Pr2	min	0 to 255 min
ALr	dA2	Second temperature alarm delay at start-up	00:00	Pr2	hh:mm	0.0 to 24h00min
ALr	bLL	Compressor OFF due to second low temperature alarm	no	Pr2		n(0); Y(1)
ALr	AC2	Compressor OFF due to second high temperature alarm	n	Pr2		n(0); Y(1); MAn(2)
ALr	SAF	Differential for anti-freezing control	-2.0	Pr2	°F	[-12.0°C to 12.0°C] [-21.6°F to 21.6°F]
ALr	tbA	Alarm relay deactivation	no	Pr2		n(0); Y(1)
oUt	oA2	Relay output oA2 configuration	dEF	Pr2		nu(0); CP1(1); dEF(2); FAn(3); ALr(4); LiG(5); AUS(6); db(7); onF(8); HES(9); Cnd(10); CP2(11); dF2(12); HET(13); inv(14)
oUt	oA3	Relay output oA3 configuration	FAn	Pr2		nu(0); CP1(1); dEF(2); FAn(3); ALr(4); LiG(5); AUS(6); db(7); onF(8); HES(9); Cnd(10); CP2(11); dF2(12); HET(13); inv(14)
oUt	oA4	Relay output oA4 configuration	LiG	Pr2		nu(0); CP1(1); dEF(2); FAn(3); ALr(4); LiG(5); AUS(6); db(7); onF(8); HES(9); Cnd(10); CP2(11); dF2(12); HET(13); inv(14)
oUt	AOP	Alarm relay polarity	CL	Pr2		oP(0); CL(1)
inP	ibt	Base times for digital inputs	Sec	Pr1		SEC(0); Min(1)
inP	i1P	Digital input 1 polarity	CL	Pr1		oP(0); CL(1)
inP	i1F	Digital input 1 configuration	dor	Pr1		nu(0); dor(1); dEF(2); AUS(3); ES(4); EAL(5); bAL(6); PAL(7); FAn(8); HdF(9); onF(10); LiG(11); CC(12); EMt(13)
inP	did	Digital input 1 alarm delay (base time depends on par. ibt)	0	Pr1	sec	0 to 255 min/sec
inP	i2P	Digital input 2 polarity	CL	Pr1		OP(0); CL(1)
inP	i2F	Digital input 2 configuration	EAL	Pr1		nu(0); dor(1); dEF(2); AUS(3); ES(4); EAL(5); bAL(6); PAL(7); FAn(8); HdF(9); onF(10); LiG(11); CC(12); EMt(13)

inP	d2d	Digital input 2 alarm delay (base time depends on par. ibt)	0	Pr1	sec	0 to 255 min/sec
inP	nPS	Number of external pressure switch alarms before stopping the regulation	0	Pr2		0 to 15
inP	odC	Compressor and fan status after door opening	no	Pr2		no(0); FAn(1); CPr(2); F-C(3)
inP	rrd	Regulation restart after door alarm	no	Pr2		n(0); Y(1)
ES	ErA	Energy saving algorithm	nu	Pr2		nu(0); bAS(1)
ES	HES	Energy saving mode temperature differential	0	Pr1	°F	[-30°C to 30°C] [-54°F to 54°F]
ES	LdE	Energy saving controls the lights (lights OFF when energy saving mode is active)	no	Pr1		n(0); Y(1)
ES	StE	Period to switch from normal mode to energy saving mode	00:00	Pr1	hh:mm	0 to 23h50min; nu
ES	EtS	Period to switch from energy saving mode to normal mode	00:00	Pr1	hh:mm	0 to 23h50min; nu
ES	dS	Door opening time to switch from EtS to StE	0	Pr1	sec	0 to 999 sec
Cnt	n1H	Number of activations for relay output oA1 (thousands of)		Pr1		read only
Cnt	n1L	Number of activations for relay output oA1 (units of)		Pr1		read only
Cnt	n2H	Number of activations for relay output oA2 (thousands of)		Pr1		read only
Cnt	n2L	Number of activations for relay output oA2 (units of)		Pr1		read only
Cnt	n3H	Number of activations for relay output oA3 (thousands of)		Pr1		read only
Cnt	n3L	Number of activations for relay output oA3 (units of)		Pr1		read only
Cnt	n4H	Number of activations for relay output oA4 (thousands of)		Pr1		read only
Cnt	n4L	Number of activations for relay output oA4 (units of)		Pr1		read only
Cnt	n5H	Number of total activations of digital input 1 (thousand of)		Pr1		read only
Cnt	n5L	Number of total activations of digital input 1 (units of)		Pr1		read only
Cnt	n6H	Number of total activations of digital input 2 (thousand of)		Pr1		read only
Cnt	n6L	Number of total activations of digital input 2 (units of)		Pr1		read only
Cnt	F1H	Number of working hours for relay output oA1 (thousands of)		Pr1	hours	read only
Cnt	F1L	Number of working hours for relay output oA1 (units of)		Pr1	hours	read only
Cnt	F2H	Number of working hours for relay output oA2 (thousands of)		Pr1	hours	read only
Cnt	F2L	Number of working hours for relay output oA2 (units of)		Pr1	hours	read only
Cnt	F3H	Number of working hours for relay output oA3 (thousands of)		Pr1	hours	read only
Cnt	F3L	Number of working hours for relay output oA3 (units of)		Pr1	hours	read only
Cnt	F4H	Number of working hours for relay output oA4 (thousands of)		Pr1	hours	read only
Cnt	F4L	Number of working hours for relay output oA4 (units of)		Pr1	hours	read only
rtC	Hur	Hours		Pr1		read only
rtC	Min	Minutes		Pr1		read only
rtC	dAY	Day of the week		Pr1		read only
rtC	dYM	Day of the month		Pr1		read only

rtC	Mon	Month		Pr1		read only
rtC	YAr	Year		Pr1		read only
rtC	Hd1	First day of weekend	nu	Pr2		Sun(0) to SAt(6); nu(7)
rtC	Hd2	Second day of weekend	nu	Pr2		Sun(0) to SAt(6); nu(7)
rtC	iLE	Energy saving cycle start time on working days	00:00	Pr2	hh:mm	0.0 to 23h50min
rtC	dLE	Energy saving cycle duration on working days	00:00	Pr2	hh:mm	0.0 to 24h00min
rtC	iSE	Energy saving cycle start time on weekends	00:00	Pr2	hh:mm	0.0 to 23h50min
rtC	dSE	Energy saving cycle duration on weekends	00:00	Pr2	hh:mm	0.0 to 24h00min
rtC	dd1	Sunday defrost	no	Pr2		n(0); Y(1)
rtC	dd2	Monday defrost	no	Pr2		n(0); Y(1)
rtC	dd3	Tuesday defrost	no	Pr2		n(0); Y(1)
rtC	dd4	Wednesday defrost	no	Pr2		n(0); Y(1)
rtC	dd5	Thursday defrost	no	Pr2		n(0); Y(1)
rtC	dd6	Friday defrost	no	Pr2		n(0); Y(1)
rtC	dd7	Saturday defrost	no	Pr2		n(0); Y(1)
rtC	Ld1	1st defrost start time	00:00	Pr2	hh:mm	0.0 to 23h50min(143); nu(144)
rtC	Ld2	2nd defrost start time	00:00	Pr2	hh:mm	0.0 to 23h50min(143); nu(144)
rtC	Ld3	3rd defrost start time	00:00	Pr2	hh:mm	0.0 to 23h50min(143); nu(144)
rtC	Ld4	4th defrost start time	00:00	Pr2	hh:mm	0.0 to 23h50min(143); nu(144)
rtC	Ld5	5th defrost start time	00:00	Pr2	hh:mm	0.0 to 23h50min(143); nu(144)
rtC	Ld6	6th defrost start time	00:00	Pr2	hh:mm	0.0 to 23h50min(143); nu(144)
E2	MAP	Current configuration	0	Pr1		C-1(0); C-2(1)
E2	LdM	Restore default factory setting	0	Pr2		n(0); Y(1)
E2	rHA	Reset Haccp values	0	Pr2		n(0); Y(1)
CoM	Adr	Serial address	1	Pr2		1 to 247
CoM	bAU	Baudrate	9.6	Pr2		9.6(0); 19.2(1); 38.4(2); 57.6(3);
CoM	PAr	Parity control	no	Pr2		no(0); odd(1); EvE(2)
Ui	SCS	User interface timeout	60	Pr2	sec	1 to 255 sec
Ui	bS	Sound Level	3	Pr2		0 to 5
Ui	PSU	Password for protected level Pr2		Pr2		0 to 999
inF	dP1	Probe P1 value visualization		Pr1		read only
inF	dP2	Probe P2 value visualization		Pr1		read only
inF	dP3	Probe P3 value visualization		Pr1		read only
inF	dP4	Probe P4 value visualization		Pr1		read only
inF	rSE	Real regulation Set Point (SET + ES + SETd)		Pr1		read only
inF	FdY	Firmware release date: day		Pr1		read only
inF	FMn	Firmware release date: month		Pr1		read only
inF	FYr	Firmware release date: year		Pr1		read only
inF	rEL	Firmware release		Pr1		read only
inF	SUB	Firmware sub release		Pr1		read only
inF	Ptb	Parameter map version		Pr1		read only

NOTE: some parameters are not present in XR30T and XR60T models due to lack of the relevant I/O's.

6. REGULATION

The regulation is based on the temperature measured by the thermostat probe (P1) with a positive differential compared to the set point: if the temperature increases and reaches the set point plus differential, the compressor will start. The compressor will stop when the temperature reaches the set point value again. In case of fault because of the thermostat probe, the start and stop of the compressor are timed through parameters **CoF** and **Con**.

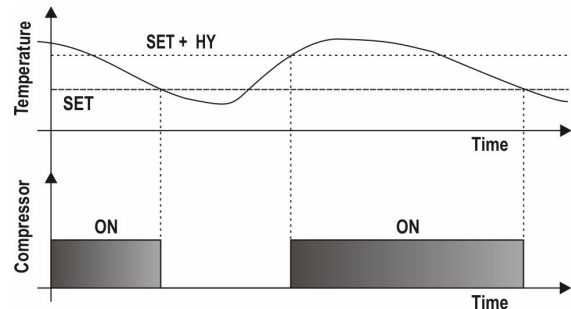

7. ENERGY SAVING

The standard SET-POINT (**SET**) is used to maintain the temperature at a certain value when the energy saving status (ES) is not active. On the other hand, when the ES status is active a different SET-POINT (**SET_ES**), higher than the standard one, will be used. The parameter **HES** defines the energy setpoint according to the following formula: **SET_ES = SET + HES**

There are also two different differential values for **SET** and **SET_ES**, which are used for compressor cut-in and cut-out: when ES status is active, the **HYE** parameter will be used instead of the **HY** parameter.

7.1 BASIC ENERGY SAVING ALGORITHM

The energy saving status will be always saved in the internal memory to resume previous operation if a power failure occurs. The presence of a door switch to work properly (for example: **i1F=dor**) is required.

7.1.1 PARAMETERS INVOLVED

- **ErA**: energy saving algorithm
- **i1F** or **i2F**: set as door input to monitor the appliance usage
- **StE**: interval to switch from normal to energy saving mode
- **EtS**: interval to switch from energy saving to normal mode
- **HES**: SETPOINT differential when energy saving mode active
- **HYE**: regulation differential when energy saving mode is active
- **dS**: interval for open door detection
- **LdE**: light output controlled by energy saving (OFF when energy saving mode is active)

FROM	TO	MODE
Normal mode	Energy Saving	Activate the ECO function from Virtual Keyboard screen. Door continuously closed for time StE .
Energy Saving	Normal mode	Activate the ECO function from Virtual Keyboard screen. Controller in ES mode for time EtS . If the controller is in ES mode, it returns in Standard mode when the door stays open more than time dS .

NOTE: the cycling mode (ES - Normal mode - ES - etc.) works if **i1F=dor**, **EtS** and **StE** are different from zero. If **EtS=0** or **StE=0**, the controller will not change the operating mode, and it will be possible to change from the normal mode to the energy saving mode by using the ES button or by setting **i1F=ES**.

8. PULL DOWN FUNCTION

The Pull Down is automatically activated:

- After any defrost cycle
- After power-on if **T>SET+CCS**
- When the regulation probe temperature **T** is:
 - **T>SET+HY+oHt** value in normal mode
 - **T>SET+HES+HYE+oHE** value in energy saving mode

In these cases, a different set-point value (**SET+CCS**) will be used. As soon as the room temperature reaches the **SET+CCS** value, the compressor will stop and the normal regulation will restart.

NOTE:

- Pull Down function is disabled when **CCS=0** or **Cct=0**.
- The **Cct** parameter sets the maximum activation time for any pull down. When **Cct** expires, the Pull Down will be immediately stopped and the standard SET-POINT will be restored

9. DEFROST OPERATIONS

Any defrost operation can be controlled in the following way:

- **EdF=rtC**: by using an internal real-time clock (only for models equipped with RTC)
- **EdF=in**: timed defrost, in this case a new defrost will start as soon as the idF timer elapses

9.1 TIMED OR TEMPERATURE CONTROLLED MODE

Two defrost modes are available: timed or controlled by a temperature probe. A couple of parameters are required to control intervals between defrost cycles (**idF**) and maximum duration (**MdF**). During a defrost cycle it is possible to select some different visualizations by using the par. **dFd**. Available defrost types are:

- **tdF=EL**: with an electric heater
- **tdF=in**: by using hot gas cycle

10. EVAPORATOR FAN

To enable the evaporator fan management, setting set an evaporator probe is required (par. **FAP**). Here are the involved parameters:

- **FAP**: to select the control probe
- **FSt**: to select the deactivation set point
- **HYF**: differential
- **FnC**: to define the working mode:
 - **C-n**: in parallel with compressor output and stopped during any defrost. When compressor is OFF, they will start a duty-cycle mode (see **FoF**, **Fon**, **FF1** and **Fo1** parameters)
 - **O-n**: always on, stopped during any defrost
 - **C-Y**: in parallel with compressor output and always on during any defrost. When compressor is OFF, they will start a duty-cycle mode (see **FoF**, **Fon**, **FF1** and **Fo1** parameters)
 - **o-Y**: always on
- **Fnd**: activation delay after any defrost

10.1 EVAPORATOR FAN AND DIGITAL INPUT

When a digital input is configured as a door switch (**i1F** or **i2F=dor**) and this digital input is active, evaporator fan and compressor status will depend on par. **odC**:

- **odC=no**: normal regulation
- **odC=FA**n: evaporator fan OFF
- **odC=CPr**: compressor OFF
- **odC=F-C**: compressor and evaporator fan OFF

When **rrd=Y**, the regulation restarts after **d1d** or **d2d** time.

11. CONDENSER FAN

To enable the condenser fan management, setting a condenser probe is required (par. **FAC**). Here are the involved parameters:

- **FAC**: to select the control probe
- **St2**: to select the deactivation setpoint
- **HY2**: differential
- **FCC**: to define the working mode:
 - **C-n**: in parallel with compressor output and stopped during any defrost. When compressor is OFF, they will start a duty-cycle mode (see **FoF**, **Fon**, **FF1** and **Fo1** parameters)
 - **O-n**: always ON, stopped during any defrost
 - **C-Y**: in parallel with compressor output and always on during any defrost. When compressor is OFF, they will start a duty-cycle mode (see **FoF**, **Fon**, **FF1** and **Fo1** parameters)
 - **o-Y**: always on

12. DIGITAL OUTPUTS

Depending on the model, one or more digital outputs (relays) can be configured with one of the following functionalities.

12.1 COMPRESSOR OUTPUT (oAx = CP1)

With **oAx=CP1** the relay operates as the main regulation output.

12.2 DEFROST OUTPUT (oAx = dEF)

With **oAx=dEF** the relay operates as a defrost output.

12.3 EVAPORATOR FAN OUTPUT (oAx = FAn)

With **oAx=FAn** the relay operates as an evaporator fan output.

12.4 ALARM OUTPUT (oAx = ALr)

With **oAx=ALr** the output operates as an alarm output. It is activated every time an alarm happens. Its status depends on the **tbA** parameter: if **tbA=Y**, the output is deactivated by pressing any key. If **tbA=n**, the alarm output stays on until the alarm condition recovers.

12.5 LIGHT OUTPUT (oAx = LiG)

With **oAx=LiG** the relay operates as a light output.

12.6 AUXILIARY OUTPUT (oAx = AUS)

The auxiliary output can be managed by digital inputs (**oAx=AUS**, **i1F** or **i2F=AUS**): the output is switched on and off following the relative digital input status.

12.6.1 AUXILIARY REGULATOR

The auxiliary regulator can be used to manage the auxiliary output. Here are the involved parameters:

- **ACH**: type of regulation for the auxiliary relay: **Ht** = heating; **CL** = cooling
- **SAA**: set point for auxiliary relay
- **SHY**: auxiliary relay differential
- **ArP**: probe for auxiliary relay
- **Sdd**: auxiliary output off during defrost

12.6.2 TIMED ACTIVATION

The following parameters can be used to define fixed activation and deactivation intervals.

- **btA**: base time for auxiliary output activation and deactivation intervals
- **Ato**: auxiliary activation interval
- **AtF**: auxiliary deactivation interval

12.6.3 GENERAL NOTES

if **oAx=AUS** and **ArP=nP** (no probe for auxiliary digital output) the AUX output can be managed:

- by digital input if **i1F=AUS** or **i2F=AUS**
- by auxiliary button (if set as **AUS**)
- by serial command (Modbus protocol)
- by fixed interval of time if **Ato>0** and **AtF>0** (if **Ato=0** or **AtF=0** the auxiliary output is disabled)

12.7 DEAD BAND REGULATION (oAx = db)

With **oAx=db** the output can be used to control a heater element, for example. It is used to implement a dead band regulation. If so:

- **oAx=db** cut in is **SET-HY**
- **oA1=db** cut out is **SET**

12.8 ON/OFF OUTPUT (oAx = onF)

When **oAx=onF**, the output is activated when the controller is switched on and deactivated when the controller is switched off.

12.9 ENERGY SAVING OUTPUT (oAx = HES)

When **oAx=HES**, the output is activated when the energy saving mode is active and vice-versa.

12.10 CONDENSER FAN OUTPUT (oAx = Cnd)

With **oAx=Cnd** the relay operates as a condenser fan output.

12.11 SECOND COMPRESSOR OUTPUT (oAx = CP2)

With **oAx=CP2** the relay operates as a second regulation output. This function is available only for special models and normally must be not selected.

12.12 SECOND DEFROST OUTPUT (oAx = dF2)

With **oAx=dF2** the relay operates as second defrost output. This function is available only for special models and normally must be not selected.

12.13 HEATER OUTPUT (oAx = HEt)

With **oAx=HEt** the relay operates as a heater output. In this case, it will be used during and after any defrost cycle. The par. **Hon** defines the time the relative output will stay active after the end of a defrost operation.

12.14 INVERTER OUTPUT (oAx = inV)

Function not available for this model.

13. DIGITAL INPUTS

The digital inputs are programmable by using par. **i1F** and **i2F**.

13.1 DOOR SWITCH (ixF=dor)

It signals the door status. Some relay outputs can be toggled depending on the **odC** parameter:

- **odC = no** no change
- **odC = FAn** evaporator fan will be switched off
- **odC = CPr** compressor will be switched off
- **odC = F-C** both compressor and evaporator fan will be switched off

Since the door is opened:

- the door alarm is enabled
- the display shows the message "dA"
- the regulation restarts only if **rrd = Y**.

The alarm stops as soon as the external digital input is disabled again. During open door conditions, the high and low temperature alarms are disabled.

13.2 START DEFROST (ixF=dEF)

It starts a defrost if all conditions are fulfilled (temperature, delays, etc.). After finishing a defrost, the normal regulation will restart only if the digital input is disabled, otherwise the instrument will wait until the **MdF** safety time is expired.

13.3 AUXILIARY OUTPUT (ixF=AUS)

The AUX output (if present and configured) will be enabled / disabled following the status of the relative digital input.

13.4 ENERGY SAVING (ixF=ES)

The energy saving mode will be enabled / disabled following the status of the relative digital input.

13.5 EXTERNAL WARNING ALARM (ixF=EAL)

It is used to detect an external alarm. It does not lock the regulation.

13.6 EXTERNAL LOCK ALARM (ixF=bAL)

It is used to detect any critical external alarm. It locks immediately the regulation.

13.7 EXTERNAL PRESSURE ALARM (ixF=PAL)

It is used to detect any pressure external alarm. This signal locks the regulation after detecting **nPS** events in the interval **dxd**.

13.8 EVAPORATOR FAN MODE (ixF=FA_n)

It is used to control the evaporator fan.

13.9 REMOTE HOLIDAY MODE (ixF=HdF)

It is used to force the holiday mode.

13.10 REMOTE ONOFF (ixF=onF)

It is used to switch ON and OFF the device remotely.

13.11 LIGHT OUTPUT (ixF=LiG)

It is used to control the light output.

13.12 CHANGE CONFIGURATION (ixF=CC)

It is used to change the controller configuration.

13.13 MOTION SENSOR DETECTOR (ixF=EMt)

It is used to connect an X-MOD motion sensor. Please note that motion sensor can be connected only to the HOTKEY port, so digital input 2 must be properly configured.

14. ALARM SIGNALLING

Label	Cause	Outputs
P1	P1 probe failure	Compressor output according to Con e CoF
P2	P2 probe failure	Depends on the relative function
P3	P3 probe failure	Depends on the relative function
P4	P4 probe failure	Depends on the relative function
HA	High temperature alarm	Outputs unchanged
LA	Low temperature alarm	Outputs unchanged
H2	Second high temperature alarm	Outputs unchanged
L2	Second low temperature alarm	Outputs unchanged
dA	Open door alarm	Compressor and fan follows par. odC
EA	Warning external alarm	Outputs unchanged
CA	Lock external alarm	Outputs disabled
EE	Internal memory alarm	Outputs unchanged

14.1 ALARM RECOVERY

Probe alarms **P1**, **P2**, **P3** and **P4** are activated some seconds after detecting a fault condition in the relative probe. These alarms are automatically reset some seconds after the relative probe restarts normal operations. Always check the connections (probe – device terminals) before replacing the probe. Temperature alarms **HA**, **LA**, **H2** and **L2** are automatically reset as soon as the temperature is within the normal working range. It is possible to reset the “**EE**” alarm by pressing any button.

The alarms **EA**, **CA** and **dA** are automatically reset as soon as the relative digital input is disabled.

The internal buzzer can be muted by touching any area of the display and only if parameter **tbA=Y**.

15. SERIAL COMMUNICATION



The device supports different baudrates (par. **bAU**) and parity control (par. **PAr**). Please check the serial network to adapt them according to the other devices. The **XJ485CX** serial interface is required to convert the TTL output into an RS485 signal.

16. INSTALLATION AND MOUNTING

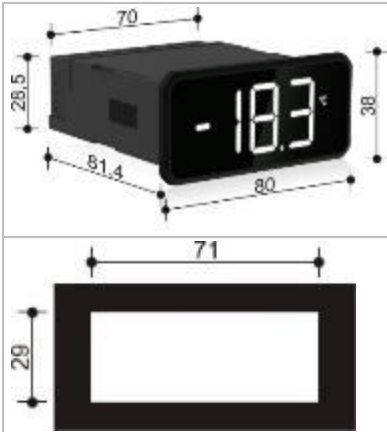

Instrument **XR-T** shall be mounted on vertical panel, in a 29x71 mm hole, and fixed using the special bracket supplied. The temperature range allowed for correct operation is 0 to 60°C. Avoid places subject to strong vibrations, corrosive gases, excessive dirt or humidity. The same recommendations apply to probes. Let air circulate through the cooling holes.

17. WIRING DIAGRAM

17.1 XR70T

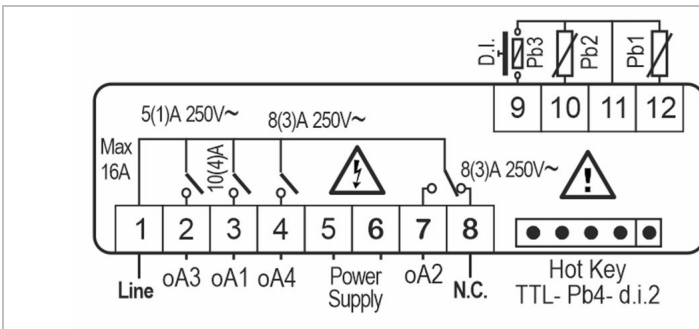

Power Supply: 110VAC, 230VAC or 100-240VAC, 50-60Hz
oA1: always set as main compressor output (CP1)

17.2 XR60T

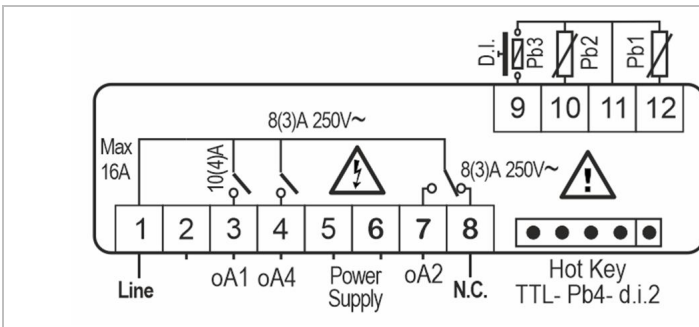

Power Supply: 110VAC, 230VAC or 100-240VAC, 50-60Hz
oA1: always set as main compressor output (CP1)

17.3 XR30T

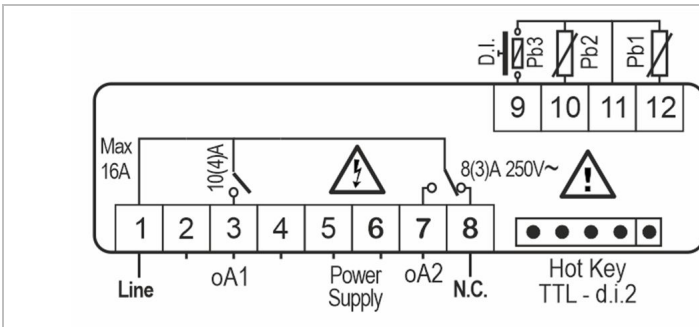

Power Supply: 110VAC, 230VAC or 100-240VAC, 50-60Hz
oA1: always set as main compressor output (CP1)

18. TECHNICAL SPECIFICATIONS

FEATURES	DESCRIPTION			
Housing	Self-extinguishing PC			
Dimensions	Front fascia 38x80 mm; case depth 81mm			
Mounting device	Panel, 71x29mm panel cut-out			
Degree of Protection	NEMA – UL 50e	Indoor use only, Type 1 enclosure		
	IP-IEC/EN 60529	Front panel: IP66	Rear Housing: IP00	
Power Supply	230Vac ±10%, 50/60Hz; 110Vac ±10%, 50/60Hz; 100 to 240VAC±10%, 50/60Hz			
Overvoltage Category	II			
Rated Power	12VAC: 3VA; 110VAC: 4VA; 230VAC: 4VA; 100-240VAC: 3VA			
Rated Impulse Voltage	2500V			
Display	White display, LED type, 3 digits with decimal point and multi-function icons			
Buzzer	Internal, always present			
Software Class	A			
Terminal blocks / Terminal Connections	Plug-in or screw terminal block, wire section between 0,5 and 2,5 mm ² Max tightening force: 0.3 N/m for 3,5mm pitch, 0.4 N/m for 5,0mm pitch			
Data Storing	Real Time Clock: Data maintenance up to 6 months with lithium battery. Other parameters: internal flash.			
Type of Action	1.B			
Pollution Degree	2, non-condensing humidity			
Ambient Operating Temperature and Humidity	IEC/EN	0T60°C; 20-85 rH% (non-condensing humidity)		
	UL-CAN/CSA	-20T60°C; 20-85 rH% (non-condensing humidity)		
Shipping and storage temperature	-40T85°C; 20-85 rH% (non-condensing humidity)			
Resistance to Heat	UL 94 V-0			
Measurement range	NTC: -40T110°C, resolution 0.1°C or 1°C (selectable); PT1000: -100T150°C, resolution 0.1°C or 1°C (selectable); PTC: -50T150°C, resolution 0.1°C or 1°C (selectable)			
Accuracy	±1% compared to the full scale			
Inputs	Up to 4 NTC, PTC or PT1000 (configurable); Up to 2 voltage free contacts			
Relay Outputs		Nominal	UL	IEC
	oA1	SPST 16A, 250Vac	Resistive load 12A (NO), 230Vac, 50K cycles Motor load 240Vac (NO), 10FLA/60LRA, 30K cycles Pilot Duty B300 (NO), 6K cycles	10(4)A (NO), 230Vac, 100K cycles
	oA2	SPDT 8A, 250Vac	Resistive load 10A (NO), 120/240Vac, 30K cycles Motor load ½ HP (NO), 240Vac, 30K cycles Motor load ¼ HP (NO), 120Vac, 30K cycles Pilot duty B300 (NO), 30K cycles	8(3)A (NO), 230Vac, 50K cycles
	oA3 (*)	SPST 5A, 250Vac	Resistive load 5A, 120/240Vac, 50K cycles Motor load 240Vac, 1.9FLA/11.4LRA, 30K cycles Pilot Duty B300, 30K cycles	5(1)A, 230Vac, 50K cycles
	oA4 (**)	SPST 8A, 250Vac	Resistive load 10A (NO), 120/240Vac, 30K cycles Motor load ½ HP (NO), 240Vac, 30K cycles Motor load ¼ HP (NO), 120Vac, 30K cycles Pilot duty B300 (NO), 30K cycles	8(3)A (NO), 230Vac, 50K cycles
Maximum ampacity on common terminal "Line" (for oAx)	16A			
I/O port	HOT-KEY: MAX voltage allowed is 5 VDC. DO NOT CONNECT ANY EXTERNAL POWER SUPPLY			
Purpose of control	Operating control			
Construction of control	Incorporated control, intended to be used in Class I or Class II equipment			
Approvals	R290/R600a: relays tested according to IEC EN60079:0 and IEC EN60079:15 IEC/EN 60730-1; IEC/EN 60730-2-9 UL 60730-1; UL 60730-2-9 CAN/CSA E60730-1; CAN/CSA E60730-2-9			

19. APPENDIX

19.1 TOOLS

19.1.1 XH-REP

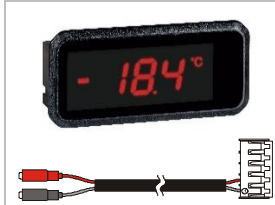

The XH-REP remote display enables the visualization of a second temperature value. A special cable must be used to connect an XH-REP to the controller (code DD200002 00). The remote display usage will disable the serial communication.

19.1.2 X-MOD



The **X-MOD** is a motion detection sensor that allows to detect the proximity of customers or service staff. 5Vdc power supply version must be used. The X_MOD usage will disable the serial communication.

19.1.3 WIZMATE



WIZMATE software, used in combination with the XJ485USB, allows to manage the configuration of the controller.

19.1.4 HOTKEY



The **HOT-KEY** is used for a quick and easy upload (from device to **HOT-KEY**) or download (from **HOT-KEY** to device) of the parameter map. The 64K version must be used (code **DK00000300**).

19.1.5 USB TO RS485 CONVERTER



XJ485USB is an optically isolated converter with 2.5kV maximum voltage isolation on data channels. It has a small plastic box with 2 indication LEDs, RX and TX, to quickly monitor the network communication. Power supply directly from USB port.

19.2 EXAMPLE OF MENU NAVIGATION AND PARAMETER MODIFICATION

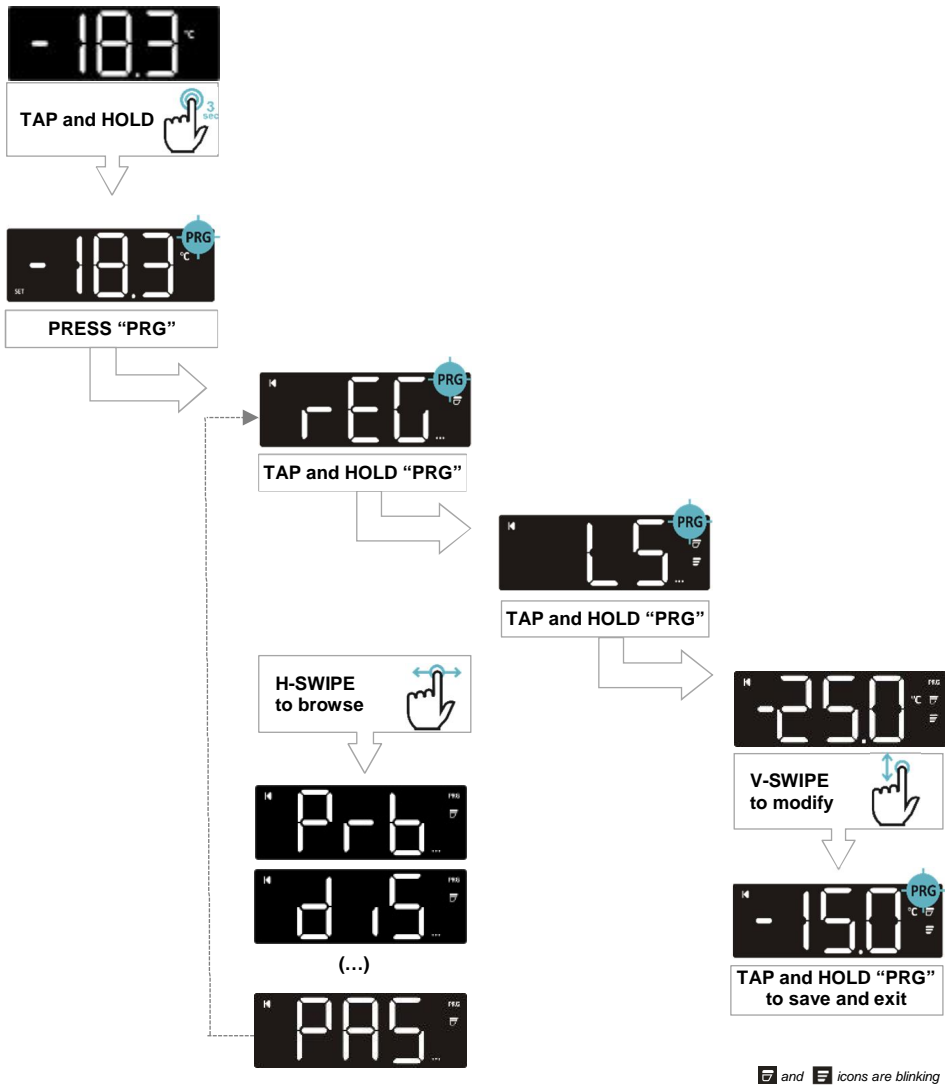

DIXELL

EMERSON

Dixell S.r.l. - Z.I. Via dell'Industria, 27 - 32016 Alpago (BL) ITALY
 Tel. +39.0437.9833 r.a. - Fax +39.0437.989313 - EmersonClimate.com/Dixell - dixell@emerson.com